

Chillers and Inverter Air/Water heat pumps with axial fans

Controller Manual

Models

i-CR



This manual has been created for informative purpose. The company declines any responsibility for the results of any projecting or any installation based on the explanations and/or on the technical specifications provided in this manual. It is besides forbidden the reproduction under any form of the texts and of the figures contained in this manual. This manual is a translation from the official Italian language version. For reasons of environmental respect the Company will not provide the hard copy in the original language which could be directly requested or downloaded from the Company website at any time. In case of any dispute, the original language manual will be the trusted one. Even partial reproduction PROHIBITED © Copyright- Advantix SpA

04	02-2020	M.S.	A.B.	Adding the chapter of Sanitary Chronothermostat and ST9, ST10, ST11, ST12, ST13 sensors
03	05-2019	D.M.	D.M.	Updates and corrections
02	02-2019	M.S.	A.B.	ID contact added
01	01-2019	M.S.	A.B.	K32, K33 parameters added
00	01-2019	A.B.	A.B.	First issue
Rev	Date	Author	Supervisor	Notes
Catalogo / Catalogue / Katalog / Catalogue MCO01138L8300-04				Serie / Series / Serie / Serie / Série i-CR chronothermostat user's and installer's manual

The electrical and electronic products and any waste should not be disposed of with normal household waste, but disposed of according to WEEE law in accordance with the directives 2012/19/EU and 2003/108/EC as amended, inquiring thereof at the place of residence or with the retailer in the case where the product is replaced with a similar one.



INDEX

1	GENERAL INFORMATION.....	4
1.1	TECHNICAL DATA	4
2	INSTALLATION.....	4
3	WIRING	5
4	KEYBOARD	6
5	DISPLAY	6
6	KEYBOARD BLOCK.....	7
7	MAIN MENU	8
7.1	PSS.....	8
7.2	SETT AIR	8
7.3	MODE.....	8
7.4	HIST	9
7.5	PAR.....	9
7.5.1	<i>Set</i>	9
7.5.2	<i>Configuration Parameters</i>	9
7.6	ERR.....	10
7.7	DATE.....	10
7.8	FOR.....	10
7.9	SYS.....	10
7.10	ROOM THERMOSTAT	11
7.10.1	<i>Summer mode</i>	11
7.10.2	<i>Winter mode</i>	11
7.11	DIGITAL INPUT.....	11
7.12	ANTILEGIONELLA FUNCTION.....	11
7.13	ALARMS.....	11
7.14	CHRONOTHERMOSTAT	12
7.14.1	<i>ROOM CHRONOTHERMOSTAT</i>	12
7.14.1.1	<i>Season selection</i>	12
7.14.2	<i>SANITARY CHRONOTHERMOSTAT</i>	13
7.14.2.1	<i>Day selection</i>	13
7.14.2.2	<i>Season selection</i>	13

1 GENERAL INFORMATION

The i-CR device is a Modbus remote control panel with negative LCD and capacitive buttons.

This device can be used as a remote control panel for the machine. It is equipped with a local sensor for temperature detection and it is able to reproduce some of the functions of the on-board control panel.

Remote control panel with the roles of:

- Reproduction of some functions of the on-board control panel (temperature probe reading, access to query parameters)
- Weekly programmable ambient chronothermostat.
- Anti-Legionella cycle.
- Alarm log

In case of the on-board control panel mode, you can display only the corresponding menus.

The main page shows by default the room temperature and allows to activate the operating icons based on the machine functions.

In case of alarm, the display shows the alarm code instead of the room temperature value.

NOTES:

- It can control only an individual unit, it is not able to manage a network of units.
- With the arrow buttons, you can display the current time instead of the room temperature.

1.1 TECHNICAL DATA

Supply voltage	12Vac/dc ($\pm 10\%$)
Supply frequency	50/60Hz
Power	1.5 VA
Insulation class	II
Protection rating	IP20
Operating ambient temperature	-25°C / +60°C
⁽¹⁾ Operating humidity	0% - 80%
Ambient temperature for storage	-30°C - 70°C
⁽¹⁾ Ambient humidity for storage	0% - 90%
Overall dimensions	133 x 80.7 x 24 mm
Communication	Serial RS485 Modbus master Modbus
Air temperature probe	Accuracy is +/- 0.5°C; Range 0°C – 70°C
⁽²⁾ Class of the device	4
⁽²⁾ Control contribution	2%

(1) No condensing.

(2) According to REG EU 2013-811.

2 INSTALLATION

The control is designed to be fixed to the wall according to DIN 503 standard. Indoor use.

On its back, there are some pre-drilled holes which can be removed by exerting the required force with a manual screwdriver, in order to get fixing holes.

Before carrying out such operation, open the control panel itself by applying a slight pressure on its lower and upper parts, so as to separate the rear panel from the front panel.

Use the rear panel and apply the holes in the two slots.

Do not use the rear panel directly as a template for making holes in the wall, the electronic components may be damaged during this operation.

To open the i-CR remote control panel, follow the steps detailed below:

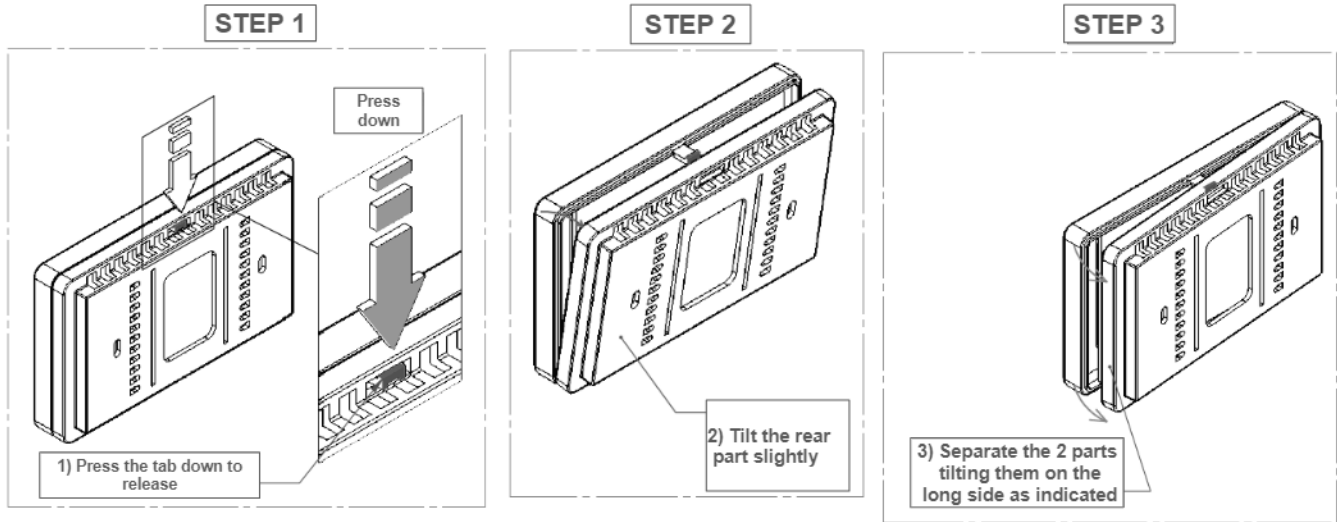

3 WIRING

You need two cables for the connection between the i-CR remote control panel and the water chiller/heat pump unit:

- 3x1.5mm² twisted and shielded cable for Modbus communication R+/R-/GND
- 2x1.5mm² cable for 12Vac power supply

	DESCRIPTION	i-CR TERMINALS	CHILLER/HEAT PUMP TERMINALS	NOTES
CABLE 1	POWER SUPPLY	PIN 12	12Vac	
		PIN 13	12Vac	
CABLE 2	COMMUNICATION	PIN 9	GND RS485	SHIELDED AND TWISTED PAIR CABLE
		PIN 7	RS485 +	
		PIN 8	RS485 -	
CABLE 3	DIGITAL INPUT	PIN 1		VOLTAGE-FREE CONTACT
		PIN 2		



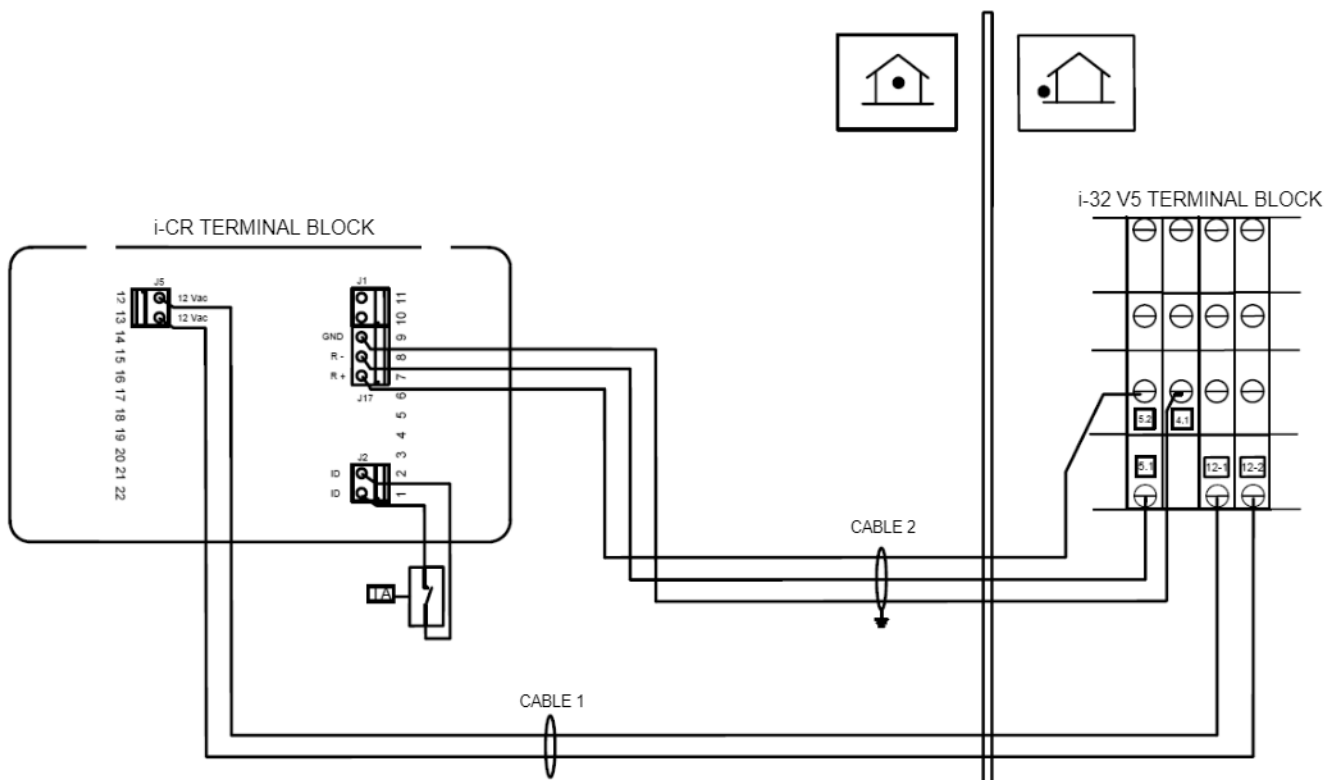



Example: i-CR coupled with I-32V5 heat pump unit



4 KEYBOARD

The backlights of the LEDs will automatically turn off when the “i-CR” remote control panel has not been used for more than 1 minute. In such case, if you press any button for first time, the display will be activated and the LEDs will turn on but the function associated with the key will not be performed. You have 6 enabled capacitive buttons.























BUTTON	DESCRIPTION
	<p>ON/OFF BACKLIGHT Function that acts at the thermostat level, used to turn off/on the LEDs and the backlight. In OFF mode, the keyboard does not accept any command. This function has not no effect on the setting of the machine, but it enables/disables the interaction with the Thermostat. Allows you to exit the menu. If this buttons is pressed for 3 seconds, the keyboard will lockout and the padlock icon appears on the display <u>This function has not no effect on the setting of the machine, it is just used to enable/disable the interaction of the user with the thermostat keyboard.</u></p>
	<p>UP This button allows you to move up to higher menus or to increase the value of a given parameter</p>
	<p>DOWN This button allows you to move down on lower menus or to decrease the value of a given parameter</p>
	<p>CHRONOTHERMOSTAT This allows you to set the operational time slot to regulate room temperature read by the probe on the i-Cr</p>
	<p>CHANGE SEASON BUTTON Push this button at least for 3 seconds to change the season mode or to turn the heat pump/chiller unit OFF</p>
	<p>ENTER BUTTON Use this button to enter the menus or to confirm a parameter.</p>

5 DISPLAY

The display is a negative custom LCD with white backlighting. The following is the list of main icons with relative meaning.

ICON	DESCRIPTION	NOTES
	Cooling	ON: cooling mode

ICON	DESCRIPTION	NOTES
	Heating	ON: heating mode
	Sanitary mode	ON: DHW enabled Blinking: DHW in progress
	Water drip	ON when the machine water temperature is displayed on the main page instead of the room temperature
	Manual	When chronothermostat is not active but the "mode" setting is manual
	Maximum Hz	ON when the maximum Hz function is active
	Chronothermostat	ON when the chronothermostat is active
	Economy	ON when Ecomode is active (manual or chrono-program)
	Off Mode	Mode off (manual or chrono-program)
	Active Password	It indicates that you can access the menus that are protected by password The dots indicate the password level entered
	Padlock	Indicates keyboard locked
	Alarm	Indicates an alarm is triggered
	Link error	Indicates no communication with the unit
	Pump	ON when the pump is active
	Compressor	Blinking: Unit on call ON when at least 1 compressor is working
	Anti-Legionella	On: Disinfection cycle in progress Blinking: last cycle not executed
	Antifreeze	ON when the antifreeze electric heaters are active, if present
	Solar	ON when the solar pump is active, if present
	Electric heaters	ON when plant or DHW integration electric heaters are active, if present
	Boiler	ON when boiler is activated, if present
	Defrost	ON during defrosting.

6 KEYBOARD BLOCK

- **AUTOMATIC:** It manages an automatic keyword block (standby): after **K32** (default 60 seconds) seconds with no key pressed, the LEDs switch out and the LCD brightness reduces as defined by **K33** (default 100%). The LEDs switch back on the first time a button is pressed, waking up the keyboard. The pressed button will have no other effect. When the LEDs are active, the keyboard answers as requested. For the settings see par. 7.5.2.
- **MANUAL:** Besides the automatic keyboard block as described in the machine interface paragraph, the keyboard can also be blocked manually: Pressing the ON/OFF key for 3 seconds blocks the keyboard. This situation is indicated by the padlock. Every time a key is pressed in this lock situation, the padlock blinks with the word "Lock". To unlock the keyboard, press the ON/OFF key again for 3 seconds.

7 MAIN MENU

Pressing Enter, you enter the first level menu described below. The following items can appear here:

- PSS: Password setting
- Sett: ECO and normal summer and winter ambient setpoint.
- ModE: Operating mode of the thermostat (room thermostat function)
- Hist: Alarm log
- PAr: Thermostat machine and rooms parameters
- Err: Current machine alarms
- dAtE: Date and time setting
- For: Forced manuals menu
- SYS: System status menu

Use the arrow buttons to navigate through the possible items, with the **Enter-button** you select the chosen menu, with the **ON / OFF key** you go out again.

7.1 PSS

Setting the password to enter the installer or higher menu.





7.2 Sett Air

AMBIENT setting (disabled in diS mode)

Set	Default
Coo	25.0 °C
HEA	20.0 °C
CooE	30.0 °C
HEAE	15.0 °C

7.3 ModE

Selecting the ModE menu you set the operation type.

	<p>diS: Disabled room thermostat function. Neither manual icon nor the chronothermostat icon appears. The water drip icon appears. The displayed temperature is that of the regulation probe of the heat pump or chiller (air is not settable)</p>
	<p>ComF: Room chronothermostat active. The temperature control demand will be evaluated based on the temperature read by the thermostat and on the normal ambient setpoint of the season. The displayed temperature that of the air read by the i-CR's on-board probe This mode is recognised by the presence of the manual symbol.</p>
	<p>Eco: Manual ECO Function. The temperature control demand will be evaluated based on the temperature read by the thermostat and on the ECO ambient setpoint of the season. This mode is recognised by the presence of the manual icon and leaf symbol.</p>
	<p>OFF: Ambient thermostat in manual OFF. Room temperature control always met will be sent to the machine. This mode is recognised by the presence of the manual icon and moon symbol.</p>
	<p>Cron: Active chronothermostat The temperature control demand follows the weekly chronothermostat programming that can be in one of the following bands:</p> <ul style="list-style-type: none"> ○ OFF ○ Eco ○ ComF. <p>This mode is recognised by the presence of the clock symbol indicating chronothermostat active. The active time slot is identified by the presence of the moon and of the leaf. This menu is always accessible. To set the chronothermostat see par. 7.14.</p>

7.4 HIST

This menu is used to display the alarm history stored in the machine. The alarms are displayed in reverse chronological order, the most recent alarm is displayed first.

Use the Up and Down buttons to scroll through the various records present. When the thermostat is reading a new alarm, dashed lines "----" appear briefly to indicate that the code is not yet available.

The error code "Exxx" of the saved alarm is displayed by default. Keep pressing the Enter button in order to scroll the other recorded data which are:

- Alarm time in the form hh:mm (24 hours)
- Day of the month "d0xx" (where xx = 1 – 31)
- Month "M0xx" (where xx = 1 – 12)
- Year "y0xx" (where xx = 0 – 99)

If the board had no valid date and time available when the alarm triggered, the conventional time shown is in days and hours since the last power-on of the board. In this case, the Month and Year fields do not appear and the day field can also be 0.

Note:

The "disinfection event terminates successfully" is stored with the alarms history, and is specified with the voice "ALOK" instead of the alarm acronym.

7.5 Par

This menu gives access to all the machine parameters; it is possible to set the water setpoint of the heat pump / chiller. In the first level you can see the labels of the groups. Selecting one of the groups you can log into the related parameters.

7.5.1 Set

Setting the Summer and Winter **WATER** setpoint

Water setpoint	Default
Coo	7.0°C
HEA	45.0°C
SAN	48.0°C
COO2	18.0°C
HEA2	35.0°C

7.5.2 Configuration Parameters

You can set the following configuration parameters:

Code	Description	Default Value	Minimum Limit	Maximum Limit	Unit	PSW
K01	Baudrate serial Modbus 0 = 4800 baud 1 = 9600 baud 2 = 19200 baud 3 = 38400 baud	1	0	3	Num	U
K02	Serial Modbus Parity 0 = No parity with 2 stop bits 1 = ODD parity with 1 stop bit 2 = EVEN parity with 1 stop bit 3 = No parity with 1 stop bit	2	0	3	Num	U
K03	Modbus communication timeout	60	0	120	s	U
K30	Backlighting power	100%	10	100	%	M
K31	Automatic menu exit timeout 0: No managed timeout N > 0: After N seconds without any key being pressed, you return to the main page	0	0	120	s	U
K32	Timeout to pass in standby mode 0 = No managed standby	60	0	120	s	U
K33	Brightness in standby K33 = 0: off K33 > 0: Brightness rate compared to normal mode	100%	0	100	%	U
K50	Offset weekday 0 = Monday is day 1 1 = Sunday is day 1	0	0	1	Num	M
K100	Temperature probe out of calibration	0	-10.0	10.0	°C	M

Key for password levels:

- U = User level
- M = Maintenance level

7.6 Err

In this menu you can see the active alarms in the chiller or heat pump.

With the **Up** and **Down KEYS** you can scroll the current alarms.

If there are no alarms, “noAL” appears.

The presence of an error on the chiller or heat pump is recognised by the icon .

Manual machine alarms reset: It is carried out in automatic mode by turning the machine OFF with the MODE key (with an alarm warning on the display).

7.7 dAtE

Date and time setting:

- YEAr: from 2018 to 2099
- Mon: from 1 (January) to 12 (December)
- DAY: from 1 to 31 (with dynamic limitation for some months/years)
- Hour: from 00:00 to 23:59

The day of the week is calculated automatically.

The daylight saving time (summer time) is automatically managed respecting the European Union rules.

On the Display, by default, day 1 is Monday and 7 is Sunday. By setting the **parameter K50 = 1**, day 1 will be Sunday.

Note: This menu is automatically presented to ask for inserting the current date and time, If it is detected that the date and time have been reset during the startup of the unit.

7.8 For

This menu is accessible with at least installer password, it allows you to enable some forcing on the machine:

- **dEFr:** Used to activate the manual defrost cycle. Press the **Enter** button to send the command to the machine and then exit the menu.
- **Pump:** Used to manually activate the water pump of the plant for purging the system. Press the Enter button to send the command to the machine and then exit the menu.
Note that the command is accepted by the machine only if it is set to OFF status.
- **Aleg:** It is possible to manually force a disinfection cycle (see For menu).
Once the forcing is sent to the machine with the For menu, this override is active for 60 minutes. The request is lost in case of a power failure during these 60 minutes.
The ANTILEGIONELLA function must be ENABLED in the heat pump (see relative technical manual).

7.9 SYS

System status menu; in this menu you can see some of the system parameters:

With the **Up** and **Down KEYS** you select which status to see.

Pressing **ENTER** you pass from the name of the status to its value and vice versa.

Status	Meaning
S001	Unit restart temperature
S002	Unit water outlet temperature
S003	DHW temperature
S004	Plant remote temperature
S005	Outdoor air temperature
S006	Thermostat firmware version
S007	Suction pressure
S008	Condensation pressure
S009	Compressor inlet temperature
S010	Compressor exhaust
S011	Solar collector temperature
S012	Solar storage tank temperature
S013	DHW preparer outlet temperature

Note: Shows "----" if the value is not available.

For the multi-circuit units it is possible to see only the parameters of the circuit 1.

7.10 ROOM THERMOSTAT

Function active in the (Conf, Eco, Cron) mode, the room temperature call will be sent to the heat pump/water chiller unit if:

- The machine is turned on in summer or winter mode.
and
- The room thermostat regulation is enabled (Mode other than "dis").

If the current status of the room thermostat is **OFF** (manual or programmable thermostat), the reaching of room temperature control status will be sent to the machine, otherwise the room temperature control call follows the rules below.

For details of the behaviour of the machine in absence of the room request, refer to the machine specifications.

7.10.1 Summer mode

If thermostat temperature \leq Setpoint, then call not active

If thermostat temperature \geq Setpoint + hysteresis⁽¹⁾, then call active

Notes:

- (1) Hysteresis steady at 1°C;
- The previous call status is kept in the range between setpoint and setpoint + hysteresis.
- In ECO mode, the reference setpoint is the ECO summer ambient setting.
- If the booster or secondary circulator is present, the active call acts on the state of the circulator.

7.10.2 Winter mode

If thermostat temperature \geq Setpoint, then call not active

If thermostat temperature \leq Setpoint + hysteresis⁽¹⁾, then call active

Notes:

- (1) Hysteresis steady at 1°C;
- The previous call status is kept in the range between setpoint and setpoint + hysteresis.
- In ECO mode, the reference setpoint is the ECO winter ambient setting
- If the booster or secondary circulator is present, the active call acts on the state of the circulator.

7.11 DIGITAL INPUT

It is possible to link a thermostat or a series of room thermostats with a voltage-free contact on the digital input of the i-CR.

- If the digital input is closed = to propagate the ambient temperature request even the exclusion of the chronothermostat
- If the digital input is open = it is considered that there is no call from other sources.

Note: If the compressors are active and the call is suspended, the outdoor unit reaches the water setpoint and then goes in standby mode

7.12 ANTILEGIONELLA FUNCTION

The ANTILEGIONELLA function must be ENABLED on the heat pump.

The cycle is enabled if $r34 > 0$ (1=Monday, 2=Tuesday,..., 7=Sunday).

The thermostat sends the date and time signals to the chiller for executing the anti-legionella cycle.

DHW must be enabled: $H10 > 0$.

The DHW integration heaters must be enabled: $r15 > 0$ and there must be a specifically set up relay (DO at 26).

The DHW temperature probe must be available: one analog input 6.

The request to perform the disinfection cycle is sent remotely.

The termination dates and times of anti-legionella cycle events are stored in the alarms history; unlike all other alarm events, in this case the events are indicated with the "ALOK" acronym and not with the "Exxx" alarm codes.

During the disinfection cycle the relative icon is active.

In the case that the disinfection cycle was not performed correctly, the chiller propagates the E61 error (only visible on the alarm Hist).

To manually override an antilegionella cycle, refer to chapter 7.8 For.

7.13 ALARMS

The only alarm actually present on the thermostat is the communication malfunction with the unit which must be connected to it via serial connection.

Active bell icon. 

The communication failure with the unit is indicated by the flashing acronym "Conn".

The bell icon will be activated also in case of temperature probe reading error.

Whereas the danger triangle remains on steady in case of a machine alarm.

7.14 CHRONOTHERMOSTAT

The settings of the room and sanitary chronothermostat are shown below. These settings adjust the way in which the ambient temperature call is happened during the various regulated time bands and also the enablement of domestic hot water production. In case of operating the unit by mean of enabled chronothermostat (the clock icon will be displayed), then the top right side of the display shows the band that is currently active. The current band is highlighted with a white full circle, while all the other enabled bands of the day will have be indicated with a white empty circle; nothing will appear for the disabled bands. If the time of the first band of the current day has not yet been reached, the full circle of the flashing band 1 is active to indicate that the first band has not yet been reached.

7.14.1 ROOM CHRONOTHERMOSTAT

The chronothermostat settings based on the room temperature detected by the i-Cr sensor. With the weekly scheduling, it is necessary to have set the date, see paragraph 7.7.



The CHRONO menu can be accessed by pressing the **CLOCK BUTTON** from the normal display. The clock icon keeps blinking as long as you are in this menu.

By pressing the **CLOCK BUTTON** for 3 seconds, you exit from the CHRONO area and you go back to the main screen. While pressing the **ON/OFF BUTTON**, you exit the current section.

The following images are for illustrative purposes only.

When red the segment blinks, when black it is on and grey means that it is enabled according to arrows.

7.14.1.1 Season selection

In the CHRONO section, you can choose which seasonal program to display or to change SUMMER  /WINTER  mode.

When entering the menu, the preselected programming is the one related to the current season (in OFF mode the unit starts to operate in summer mode).

The selected season icon blinks and with the 2 arrows you can change it.

Press the **ENTER BUTTON** to pursue the selection of the day of the week

7.14.1.2 Day selection

The day of the week blinks in this area. The first activated day is the current one. Select the desired day by scrolling with the arrows.

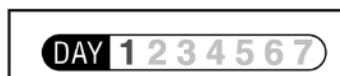

Here is an example where Monday is blinking.



Press the **ENTER BUTTON** to pursue the selection of the day of the week.

7.14.1.3 Displaying of the Daily Time Slots

In this area, by scrolling with the arrows, you display all 5 configurable time slots of the day.

The currently selected time slot is highlighted by the blinking dot. 

The time slots are scrolled with the arrows, displaying the starting time of the time slot

- The leaf icon  is ON if the time slot is ECO.
- The moon icon  is active if the time slot is OFF or disabled.
- With the time slot in Comfort, both leaf and moon icons are off.
- The symbol "----" appears on the display if the concerned time slot is disabled.

For a given time slot, you can modify:

- Its starting time
- Its operating mode, Comfort, ECO or OFF.

The arrows allow you to modify the value (blinking).



Scroll this area and confirm the value with the **ENTER BUTTON**, press the button to proceed.

First you can set the starting time of the time slot. Press the **ENTER BUTTON** to proceed.

Note that if you disable the time slot (the dashed line "----" appears instead of the time), then you cannot set the operating mode below.

Press the **ENTER BUTTON** to quit the time slot modification and to save the new setting.

The following selections are displayed:

- Comfort: "ComF" without additional icons besides the clock icon .
- ECO: "Eco" with leaf icon  active.

- OFF: "OFF" with moon icon  active.

By pressing the **ENTER BUTTON**, you exit the time slot modification saving the settings and go back to view the time slot itself. During this step the word "Save" is displayed for a few seconds indicating that the changes have been saved. With the **ON/OFF BUTTON**, you exit WITHOUT SAVING the changes.

7.14.1.4 Programming Deletion

In each section of the chronothermostat menu, when the **ON/OFF BUTTON** is pressed for 3 seconds, a deletion is performed.

- From season selection, all the programs of the blinking season are deleted.
- From day selection, all the programs of the blinking day are deleted.
- From the time slots display, the blinking time slot is deleted.

Making a cancellation, for a few seconds the display will show the word "dEL" to indicate explicitly what has just been done.

Note that for programming a day, you cannot have all the time slots disabled. In this case time slot 1 is considered OFF from 00:00 and then you have the room temperature request OFF for the whole time.

7.14.2 SANITARY CHRONOTHERMOSTAT

The chronothermostat setting based on the room temperature detected by the i-Cr sensor.

For the weekly scheduling, the date must be set, see paragraph 7.7.



Press the **CLOCK BUTTON** from the normal display to enter into CHRONO menu. The clock symbol keeps blinking as long as you are in this menu.

By pressing the **CLOCK BUTTON** for 3 seconds, you exit from the CHRONO area and you go back to the main screen. If you press the **ON/OFF BUTTON**, you exit the current section.

7.14.2.1 Day selection

The day of the week blinks in this area. The first activated day is the current one. Select the desired day by scrolling with the arrows.

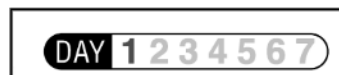

Here is an example where Monday is blinking.

7.14.2.2 Season selection

In the CHRONO section, you can select the sanitary program . After selecting this function, the sanitary symbol start to blink.

Press the **ENTER BUTTON** to pursue the selection of the day of the week

7.14.1.3 Displaying of the Daily Time Slots

In this area, by scrolling with the arrows, you display all the 5 configurable time slots of the day.



The currently selected time slot is highlighted by the blinking circle. 

The time slots are scrolled with the arrows, displaying the starting time of the time slot.

For a given time slot, you can modify:

- Its starting time
- Its operating mode, ON or OFF.
- The arrows allow you to modify the value (blinking).
- Scroll this area and confirm the value using **ENTER BUTTON**, press the button to proceed.
- First you can set the starting time of the time slot. Press the **ENTER BUTTON** to proceed.
- Note that if you disable the time slot (the dashed line "----" appears instead of the time), then you cannot set the operating mode below.
- Press the **ENTER BUTTON** to quit the time slot modification and to save the new setting.

The following selections are displayed:

- ON: "ON" item without additional any icon beside the clock icon .
- OFF: "OFF" item with moon icon  active.

By pressing the **ENTER BUTTON**, you quit the time slot modification saving the settings and go back to view the time slot itself. During this step the "Save" item is displayed for a few seconds indicating that the changes have been saved.

With the **ON/OFF BUTTON**, you quit WITHOUT SAVING the changes.

7.14.1.4 Programming Deletion

In each section of the chronothermostat menu, when the **ON/OFF BUTTON** is pressed for 3 seconds, a deletion is performed.

- From season selection, all the programs of the blinking season are deleted.
- From day selection, all the programs of the blinking day are deleted.
- From the time slots display, the blinking time slot is deleted.

Making a cancellation, for a few seconds the display will show the word "dEL" to indicate explicitly what has just been done.

Note that for programming a day, you cannot have all the time slots disabled. In this case time slot 1 is considered OFF from 00:00 and then you have the room temperature request OFF for the whole time.

Advantix SpA
Via S. Giuseppe Lavoratore 24,
37040 Arcole (VR) Italy
Tel. (+39).045.76.36.585
E-mail: info@advantixspa.it
www.maxa.it