

Synco™ 700



Heating Controller

RMH760B

- Heating controller of modular design for medium-size or large buildings with own heat source or a district heating connection. Can be used as a heating circuit controller and / or primary controller, boiler controller or DHW controller
- 41 programmed plant types
- Menu-driven operation with separate operator unit (plug-in type or detached)
- Konnex bus connection facility for operation and process information

Use

Types of buildings

- Office and administrative buildings
- Commercial buildings and shops
- Schools
- Hospitals
- Industrial buildings and workshops
- Apartment blocks and terraced houses

Types of plant

- Heating sections of ventilation and air conditioning plant
- Distribution zones of ventilation and air conditioning plant
- Heating systems with own heat generation
- Heating systems with direct or indirect district heating connection
- Heating groups of larger plant (e.g. community heating systems)
- Basic load heating systems

Functions

Note

Several of the functions listed necessitate extension modules. Refer to page 8 ff.

Control loops and control outputs

- Maximum 6 control systems with modulating output (3-position or DC 0...10 V):
 - Modulating burner
 - Heating circuit with mixing valve
 - Precontrol with mixing valve
 - Maintained boiler return temperature with mixing valve
- Control of a maximum of 6 pumps (single pumps or twin pumps)

Heating circuit control

- Control of a maximum of 3 individual heating circuits (independently)

Functions per heating circuit

- Weather-compensated flow temperature control with own outside sensor
- Mixing or pump heating circuit
- Room operating modes:
 - AUTO: Automatic changeover between 3 setpoints according to the time program
 - Comfort: Continuous heating to the Comfort setpoint
 - Precomfort: Continuous heating to the Precomfort setpoint
 - Economy: Continuous heating to the Economy setpoint
 - Protection: Heating to the setpoint of protective mode, if required
 - Delivery of current operating mode to 2 relays
- 7-day program with a maximum of 6 switching points per day
- Holiday functions:
 - Holiday and special day program with up to 16 periods per year
 - Selectable room operating mode for holidays
 - Time program for special days
- Adjustable setpoints for the room operating modes
- Adjustable room temperature influence
- Optimum start / stop control
- Boost heating and quick setback
- Room model for room functions without room temperature sensor
- Automatic heating limit for demand-dependent control of the heating system with adjustable heating limits for Comfort and Economy mode
- Automatic changeover to summer operation (heating off)
- Maximum limitation of the room temperature
- Minimum and maximum limitation of the flow temperature
- Limitation of the rate of flow temperature increase
- Outside temperature simulation
- Outside temperature-dependent frost protection for the plant
- Remote operation:
 - Remote setpoint adjuster for relative or absolute room setpoint adjustment
 - Multifunctional QAW740 room unit for a choice of heating circuit functions
 - External contacts for changeover of operating mode, timer function, etc.

Functions for all heating circuits

- Adjustable solar compensation
- Adjustable wind compensation

District heating functions

- Raising the reduced room temperature when the outside temperature drops
- Outside temperature-dependent constant-shifting-constant maximum limitation of the return temperature
- Reception of heat meter pulses for limiting the flow rate or the output

Boiler temperature control

- Control of the boiler temperature with a 1-stage, 2-stage or modulating burner (modulating burner with modulating 3-position or DC 0...10 V control, with check-back signal)
- Acquisition of the flue gas temperature, with alarm when limit value is reached
- Acquisition of the pump's flow rate
- Maximum and minimum limitation of the boiler temperature
- Maintained boiler return temperature controlled via mixing valve (3-position or DC 0...10 V), or bypass pump
- Control of a shutoff valve, with checkback signal
- Selection of boiler operating mode
- Limitation of the burner's minimum running time and of the return temperature
- Protective boiler startup
- Release of boiler
- Flue gas measuring mode (boiler test mode, chimney sweep function)
- 3 fault inputs, preconfigured for overpressure, underpressure, and water shortage
- Burner hours run meter and burner start counter

Main control

- Acquisition and evaluation of heat requests (via Konnex bus, external setpoint, external DHW request, and frost protection)
- Demand-compensated main control via mixing valve (3-position or modulating), or of the system pump installed in the main flow
- Minimum and maximum limitation of the main flow temperature
- Shifting maximum limitation of the main return temperature
- Maximum limitation of the main return temperature during DHW heating
- Reception of heat meter pulses for limiting the flow rate or the output

Precontrol

- Acquisition and evaluation of heat requests (via Konnex bus, external setpoint, external DHW request, and frost protection)
- Demand-compensated precontrol via mixing valve (3-position or modulating), or of the system pump installed in the flow
- Minimum and maximum limitation of the flow temperature
- Shifting maximum limitation of the main temperature
- Maximum limitation of the return temperature during DHW heating
- Reception of heat meter pulses for limiting the flow rate or the output

DHW heating

- Several DHW variants available:
 - Storage tank charging via internal heat exchanger
 - Storage tank charging via external heat exchanger (optionally with maintained secondary temperature)
 - Storage tank charging with electric immersion heater
 - Direct DHW consumption via heat exchanger
- Downstream consumer control (control of the DHW temperature at the tap)
- Maximum limitation of the return temperature
- Proof of flow with flow switch
- Reception of heat meter pulses for limiting the flow rate or the output
- Legionella function
- 7-day time switch with a maximum of 6 switching points per day for DHW heating
- 7-day time switch with a maximum of 6 switching points per day for the circulating pump
- Operating modes:
 - AUTO: Automatic changeover between Normal and Reduced in accordance with the time program
 - Continuously Normal
 - Continuously Reduced
 - Protection

- Holiday functions
 - Selectable DHW operating mode for holidays
 - Holiday and special day program with 16 periods per year
 - Time program for special days
- External contact for changeover of operating mode

General functions for all control loops

Yearly clock	Yearly clock with automatic summer- / wintertime changeover.
Measuring and signal inputs	All measuring and signal inputs are configurable. Signals can be: <ul style="list-style-type: none"> • LG-Ni 1000 • DC 0...10 V • Pt 1000 • T1 • NTC 575 • Digital
Data acquisition	4 meters are available for acquiring consumption values. <ul style="list-style-type: none"> • Suited for handling pulses delivered by gas, hot water, cold water and electricity meters • Pulse counting in Wh, kWh, MWh, kJ, MJ, GJ, ml, l, m³, heat cost units, BTU, or with no unit
Other control functions	<ul style="list-style-type: none"> • Control of actuators (3-position or DC 0...10 V) • Pump control • Control of twin pumps • Indication of heat demand • Configurable relays
Supervisory and protective functions	<ul style="list-style-type: none"> • Valve overrun, valve kick • Pump overrun, pump kick • Frost protection for the building • Supervision of overloads • Fault indication via red LED • Fault relay • Handling of status and fault status signals
Bus functions	<ul style="list-style-type: none"> • Remote operation of Konnex functions with RMZ792 bus operator unit • Display of fault status messages received from other devices on the bus • Delivery of common fault status messages of all devices on the bus to a fault relay • Time synchronization • Passing on and adoption of outside temperature signal • Sending yearly clock data to other controllers, or reception of yearly clock data from other controllers • Sending the 7-day or yearly program for holidays / special days to other controllers, or reception of the program from other controllers • Delivery and reception of heat demand signals • Common control strategy of a ventilation controller and heating controller for controlling the same room
Service and operating functions	<ul style="list-style-type: none"> • Wiring test • Display of setpoints, actual values and active limitations • Data protection
<i>Note</i>	For a detailed description of all controller functions, refer to the Basic Documentation (P3133).

Type summary

	<i>Type of controller</i>	<i>Type reference</i>	<i>Data Sheet</i>
Heating controllers	Heating controller (loaded languages: de, fr, it, es)	RMH760B-1	N3133
	Heating controller (loaded languages: de, en, fr, nl)	RMH760B-2	N3133
	Heating controller (loaded languages: sv, fi, no, da)	RMH760B-3	N3133
	Heating controller (loaded languages: pl, cs, sk, hu, ru, bg)	RMH760B-4	N3133
	Heating controller (loaded languages: sr, hr, sl, ro, el, tr)	RMH760B-5	N3133
Operator and service units	Operator unit (plug-in type)	RMZ790	N3111
	Operator unit (detached)	RMZ791	N3112
	Bus operator unit	RMZ792	N3113
	Service tool	OCI700.1	N5655
Extension modules	Heating circuit module	RMZ782B	N3136
	DHW module	RMZ783B	N3136
	Universal module with 4 universal inputs and 4 relay outputs	RMZ787	N3146
	Universal module with 6 universal inputs, 2 analog and 4 relay outputs	RMZ789	N3146
	Module connector for detached extension modules	RMZ780	N3138

Ordering

When ordering, please give type references according to the above list.
The required operator unit and extension modules must be ordered as separate items.
Sensors, room units, actuators and valves must also be ordered separately.

Equipment combinations

	<i>Type of sensor</i>	<i>Sensing element</i>	<i>Type reference</i>	<i>Data Sheet</i>
Suitable sensors	Outside sensor	LG-Ni 1000	QAC22	N1811
	Outside sensor	NTC 575	QAC32	N1811
	Strap-on temperature sensor	LG-Ni 1000	QAD22	N1801
	Immersion temperature sensor	LG-Ni 1000	QAE212...	N1781
	Cable temperature sensor	LG-Ni 1000	QAP21.3	N1832
	Room temperature sensor	LG-Ni 1000	QAA24	N1721
	Room temperature sensor	LG-Ni 1000	QAA64	N1722
	Wind sensor	DC 0...10 V	standard	–
	Solar sensor	DC 0...10 V	QLS60	N1943
Suitable room units	<i>Type of room unit</i>		<i>Type reference</i>	<i>Data Sheet</i>
	Room temperature sensor with setpoint adjuster		QAA25	N1721
	Room temperature sensor with setpoint readjuster		QAA27	N1721
Room unit with Konnex interface		QAW740	N1633	
Suitable remote setpoint adjusters	<i>Type of setpoint adjuster / readjuster</i>		<i>Type reference</i>	<i>Data Sheet</i>
	Remote setpoint adjuster, 0...1000 Ω signal		BSG21.1	N1991
	Remote setpoint readjuster, ±3 K		BSG21.5	N1991

Suitable actuators

All types of electromotoric and electrohydraulic actuators from Siemens

- operating on AC 24...230 V
- featuring 3-position control, or
- DC 0...10 V control

can be used.

For detailed information about the actuators and valves, refer to Data Sheets N4000...N4999.

Product documentation

Type of documentation	Document no.	Part no.
Product Range Description	S3110	–
Basic Documentation	P3133	–
Installation Instructions	G3133	74 319 0526 0
Operating Instructions (languages: de, fr, it, es)	B3133	74 319 0559 0
CE Declaration of Conformity	T3110	–
Environmental Declaration	E3110...01	–

Technical design

Mode of operation

The controller is supplied complete with 41 standard types of heating plants ready programmed. Most of them necessitate the use of extension modules. All plant types can be matched to the respective requirements (e.g. configuration as a main controller (district heating connection), configuration of twin pumps, etc.).

In addition, an empty application is provided.

With the help of the operator unit, the controller facilitates the following:

- Activation of a programmed application
- Modification of a programmed application
- Free configuration of applications
- Optimization of settings

For more detailed information, refer to the Basic Documentation (P3133).

Note

For a short description and diagrams of all plant types, refer to page 14 ff.

Overview

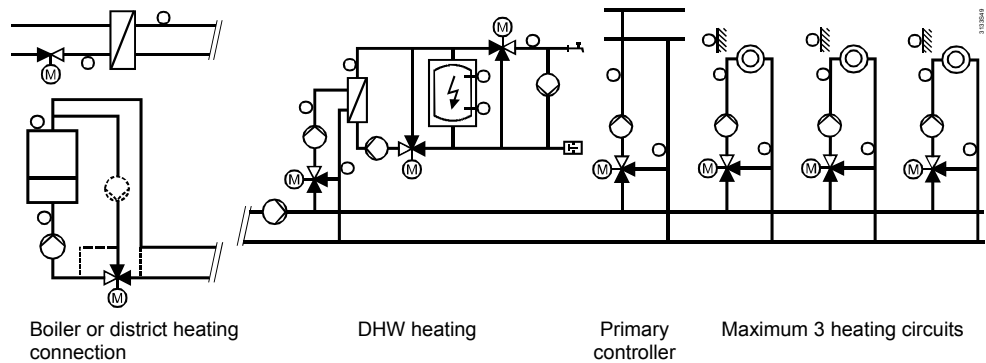

Boiler hydraulics

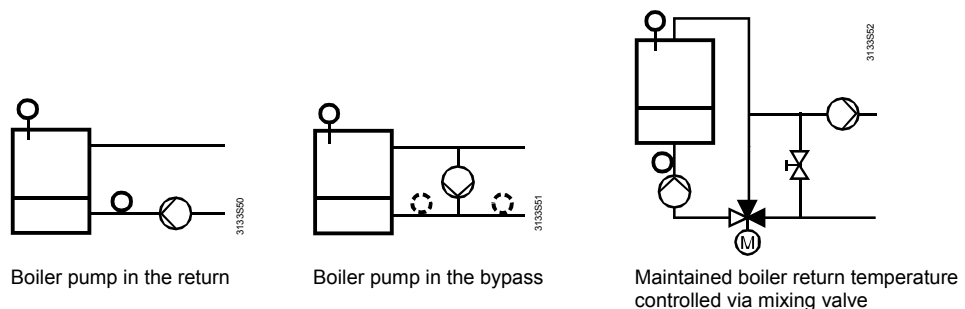

Main controller (district heating connection)

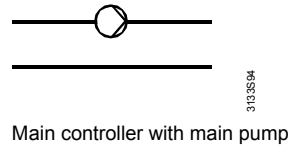
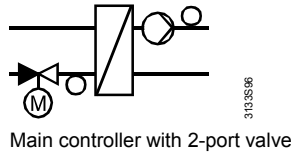

Primary controller

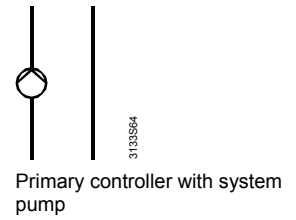
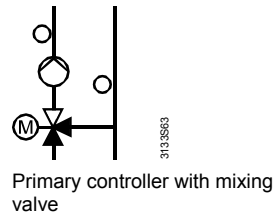
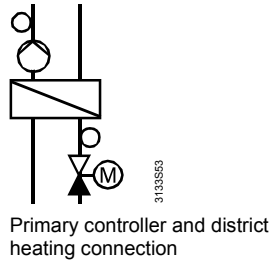

DHW heating variants

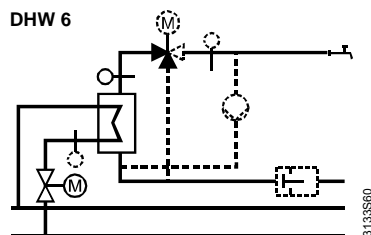
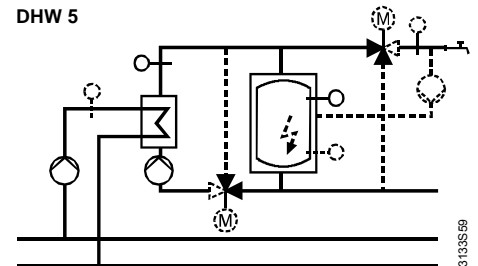
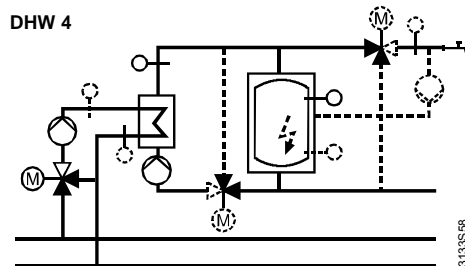
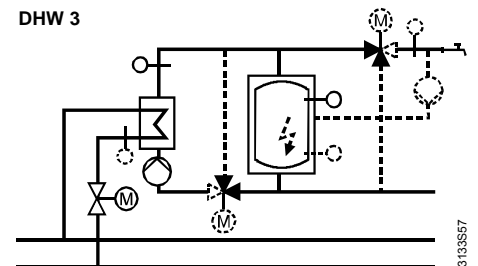
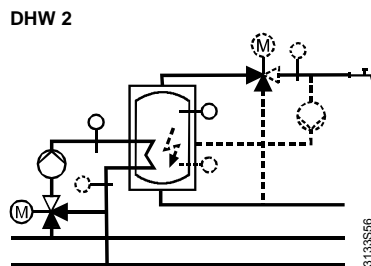
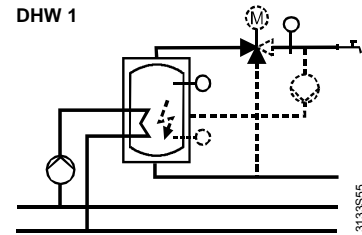
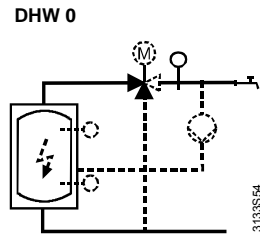

Heating circuit

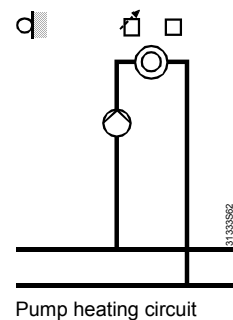
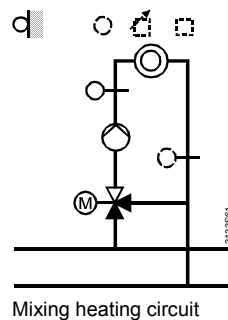
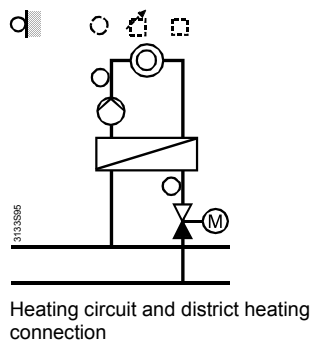

Pump control

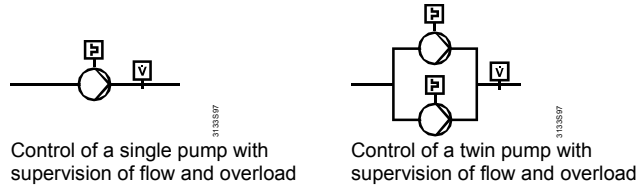

Commissioning

When commissioning the plant, the relevant plant type is to be entered. Then, all associated functions, terminal assignments, settings and displays will automatically be activated and parameters not required will be deactivated.

For more detailed information, refer to the Basic Documentation (P3133).

Use of extension modules

Extension modules are used when the standard number of inputs and outputs are not sufficient to cover all required functions:

Type of extension module	Number of uni-versal inputs	Number of analog outputs	Number of relay outputs NO	Number of relay outputs Changeover
RMZ782B	3	1	2	1
RMZ783B	4	1	3	2
RMZ787	4	–	3	1
RMZ789	6	2	2	2

A **maximum of 4** extension modules can be used while giving consideration to the following restrictions:

- Maximum 2 heating circuit modules RMZ782B
- Maximum 1 DHW module RMZ783B
- Maximum 1 universal module RMZ787
- Maximum 2 universal modules RMZ789

Mechanical design

Operating, display and connecting elements

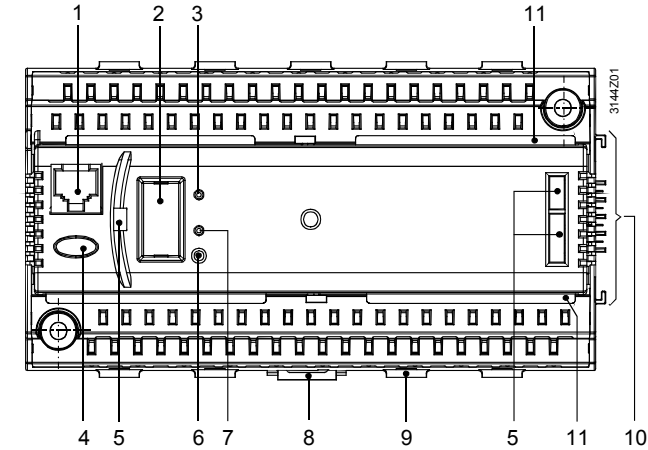

- 1 Connection facility for service interface (RJ45 socket)
- 2 Connection facility for operator unit (with removable cover)
- 3 LED (green) for indication of operation
- 4 Fault button with LED (red) for indication of faults and resetting
- 5 Openings for plug-in type operator unit RMZ790
- 6 Button for assignment of device address
- 7 LED (red) for indication of the programming process
- 8 Mounting facility for fitting the unit to a top hat rail
- 9 Fixing facility for a cable tie
- 10 Electrical and mechanical connecting elements for extension module
- 11 Rest for the terminal cover

Makeup

The heating controller consists of terminal base and insert. It has a plastic housing with the printed circuit boards, 2 terminal levels and carries the connecting elements (electrical and mechanical) for one extension module.

The controller can be fitted to a top hat rail conforming to EN 60 715-TH 35-7.5, or can be mounted directly on a wall.

Operation is facilitated via a plug-in type or detached operator unit (refer to "Type summary").

Engineering notes



- The controller can be used in connection with a **maximum of 4** extension modules
- The controller operates on AC 24 V. Operating voltage must conform to the requirements of SELV / PELV (safety extra low-voltage / protective extra low-voltage)
- The transformers used must be safety isolating transformers featuring double insulation to EN 60742 and EN 61558-2-6; they must be suited for 100 % duty
- Fuses, switches, wiring and grounding must be in compliance with local safety regulations for electrical installations
- Sensor wires should not be run parallel to mains carrying cables powering actuators, pumps, etc.
- To define the details of configuration and to generate the plant connection diagrams, the following pieces of documentation are helpful:
 - Configuration diagrams, contained in the Basic Documentation (P3132)
 - Application Sheets
- The reference room for control with a room temperature sensor should be the space that cools down quickest. That room must not be equipped with thermostatic radiator valves, and manual valves must be locked in their fully open position

Mounting and installation notes

- Controller and extension modules are designed for:
 - Mounting in standard control cabinets conforming to DIN 43880
 - Wall mounting on existing top hat rails (EN 50022-35×7,5)
 - Wall mounting with 2 fixing screws
 - Flush panel mounting
- Not permitted are wet or damp spaces. The permissible environmental conditions must be observed
- If the controller shall not be operated inside a control panel, the detached RMZ791 operator unit can be used in place of the RMZ790 plug-in type
- Prior to mounting the controller, the system must be disconnected from power
- **The controller insert must not be removed from the terminal base!**
- If extension modules are used, they must be attached to the right side of the controller in the correct order and in accordance with the internal configuration
- The extension modules require no wiring between them or from the modules to the controller. The electrical connections are made automatically when attaching the modules. If it is not possible to arrange all required extension modules side by side, the first of the detached modules must be connected to the previous module or to the controller using the RMZ780 module connector. In that case, the maximum cable length is 10 m
- All connection terminals for protective extra low-voltage (sensors, data bus) are located in the upper half of the unit, those for mains voltage (actuators and pumps) at the bottom
- Each terminal (spring cage terminals) can accommodate only one solid wire or one stranded wire. To connect the cables, the insulation must be stripped for 7 to 8 mm. To introduce the cables into the spring cage terminals and to remove them, a screwdriver of size 0 or 1 is required
- Cable strain relief can be ensured with the help of the fixing facility for cable ties
- The controller is supplied complete with Installation Instructions and Operating Instructions

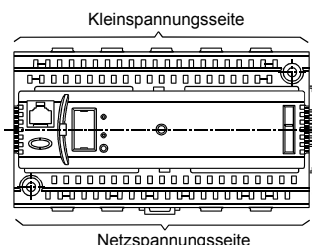

Commissioning notes

- The configuration and parameters of the standard applications programmed in the controller can be changed any time on site by personnel trained by Siemens who have the respective access rights to the plant, using the RMZ790 or RMZ791 operator unit or, online or offline, with the help of the service tool
- During the commissioning process, the application remains deactivated and the outputs are in a defined off state. During this period of time, no process and alarm signals are delivered to the bus
- On completion of the configuration, the controller will automatically be restarted
- When leaving the commissioning pages, the peripheral devices (including the extension modules) connected to the universal inputs will automatically be checked and identified. If, later, a peripheral device is missing, a fault status message will be output
- The operator unit can be removed and plugged in or connected while the controller is in operation
- Adaptations required due to specific plant conditions must be recorded and the relevant document should be stored in the control panel
- The procedure to be followed when starting up the plant for the first time is described in the Installation Instructions

Disposal notes

Larger plastic parts carry material identifications conforming to ISO/DIS 11469 to facilitate environment-compatible disposal.

Technical data

Power supply (G, G0)	Rated voltage	AC 24 V \pm 20 %
	Safety extra low-voltage / protective extra low-voltage (SELV / PELV)	to HD 384
	Requirements for external safety isolating transformer (100 % duty, max. 320 VA)	to EN 60 742 / EN 61 558-2-6
	Frequency	50/60 Hz
	Power consumption (excl. modules)	12 VA
	Supply line fusing	max.10 A
Functional data	Reserve of clock	
	Typically	48 h
	Minimum	12 h
Analog inputs X1...X6	Sensors	
	Passive	1 or 2 LG-Ni 1000, T1, Pt 1000, NTC 575
	Active	DC 0...10 V
	Signal sources	
	Passive	0...2500 Ω
	Active	DC 0...10 V
Digital inputs X1...X6	Contact sensing	
	Voltage	DC 15 V
	Current	5 mA
	Requirements for status and impulse contacts	
	Signal coupling	potential-free
	Type of contact	maintained or impulse contacts
	Insulating strength against mains potential	AC 3750 V to EN 60730
Permissible resistance		
	Contacts closed	max. 200 Ω
	Contacts open	min. 50 k Ω

Positioning output Y1, Y2**Switching outputs
Q1x...Q5x**

Output voltage	DC 0...10 V
Output current	±1 mA
Max. loading	continuous short-circuit
External supply line fusing	
Wire fuse (slow)	max. 10 A
Automatic line cutout	max. 13 A
Release characteristic	B, C, D to EN 60898
Cable length	max. 300 m
Relay contacts	
Switching voltage	max. AC 250 V / min. AC 19 V
AC current	max. 4 A res., 3 A ind. (cos φ = 0.6)
At 250 V	min. 5 mA
At 19 V	min. 20 mA
Switch-on current	max. 10 A (1 s)
Contact life at AC 250 V	Guide values:
0.1 A (res.)	2×10 ⁷ switching cycles
NO contact at 0.5 A (res.)	4×10 ⁶ switching cycles
Changeover contact at 0.5 A (res.)	2×10 ⁶ switching cycles
NO contact at 4 A (res.)	3×10 ⁵ switching cycles
Changeover contact at 4 A (res.)	1×10 ⁵ switching cycles
Reduction factor at ind. (cos φ = 0.6)	0.85
Insulating strength	
between relay contacts and system electronics (reinforced insulation)	AC 3750 V to EN 60 730-1
between neighboring relay contacts (operational insulation) Q1↔Q2; Q3↔Q4↔Q5	AC 1250 V to EN 60 730-1
between relay groups (reinforced insulation) (Q1, Q2) ↔ (Q3, Q4) ↔ (Q5)	AC 3750 V to EN 60 730-1

**Power supply external devices
G1**

Voltage	AC 24 V
Current	max. 4 A

Interfaces

Konnex bus	
Type of interface	Konnex TP1
Bus loading number	2.5
Bus power supply (decentral, can be switched off)	25 mA
Power failure of short duration to EN 50 090-2-2	100 ms with one extension module
Extension bus	
Connector specification	4 contacts SELV / PELV
Number of plugging cycles	max. 10
Service tool connection facility	RJ45 socket

Permissible cable lengths

For passive measuring and positioning signals*	
LG-Ni 1000	max. 300 m
0...1000 Ω	max. 300 m
1000...1235 Ω	max. 300 m
Contact sensing	max. 300 m
For DC 0...10 V measuring and control signals	refer to Data Sheet of signal-delivering device
For Konnex bus	max. 700 m
Type of cable	2-core, unshielded, twisted pairs

* Measuring errors can be corrected via the "Settings > Inputs" menu

Electrical connections

Connection terminals	spring cage terminals
Solid wires	0.6 mm dia...2.5 mm ²
Stranded wires without ferrules	0.25...2.5 mm ²
Stranded wires with ferrules	0.25...1.5 mm ²
Konnex bus connection	wires cannot be interchanged

Protective data

Degree of protection of housing to IEC 60 529	IP20 (when installed)
Safety class to EN 60 730	device suited for use in equipment of safety class II

Environmental conditions	Operation	to IEC 60 721-3-3
	Climatic conditions	class 3K5
	Temperature (housing with electronics)	0...50 °C
	Humidity	5...95 % r.h. (non-condensing)
	Mechanical conditions	class 3M2
	Transport	to IEC 60 721-3-2
	Climatic conditions	class 2K3
	Temperature	-25...+70 °C
	Humidity	<95 % r. h.
	Mechanical conditions	class 2M2
Classifications to EN 60 730	Mode of operation, automatic controls	type 1B
	Degree of contamination, controls' environment	2
	Software class	A
	Rated surge voltage	4000 V
	Temperature for ball-pressure test of housing	125 °C
Materials and colors	Terminal base	polycarbonate, RAL 7035 (light-grey)
	Controller insert	polycarbonate, RAL 7035 (light-grey)
	Packaging	corrugated cardboard
Standards	Product safety	
	Automatic electrical controls for household and similar use	EN 60 730-1
	Special requirements for energy controllers	EN 60 730-2-11
	Electromagnetic compatibility	
	For use in industrial and domestic environments	
	Immunity	EN 60 730-1
	Emissions	EN 60 730-1
	Home and Building Electronic Systems (HBES)	EN 50 090-2-2
	CE conformity to	
	EMC directive	89/336/EEC
	Low-voltage directive	73/23/EEC
	Conformity to	
	Australian EMC Framework	Radio Communication Act 1992
Radio Interference Emission Standard	AS/NZS 3548	
Environmental compatibility		
The environmental product declaration CE1E3110en01 contains data on environmentally compatible product design and assessments (RoHS compliance, materials composition, packaging, environmental benefit, disposal)	ISO 14001 (Environment) ISO 9001 (Quality) SN 36350 (Environmentally compatible products) 2002/95/EG (RoHS)	
Weight	Net weight excl. packaging	0.490 kg

Connection terminals

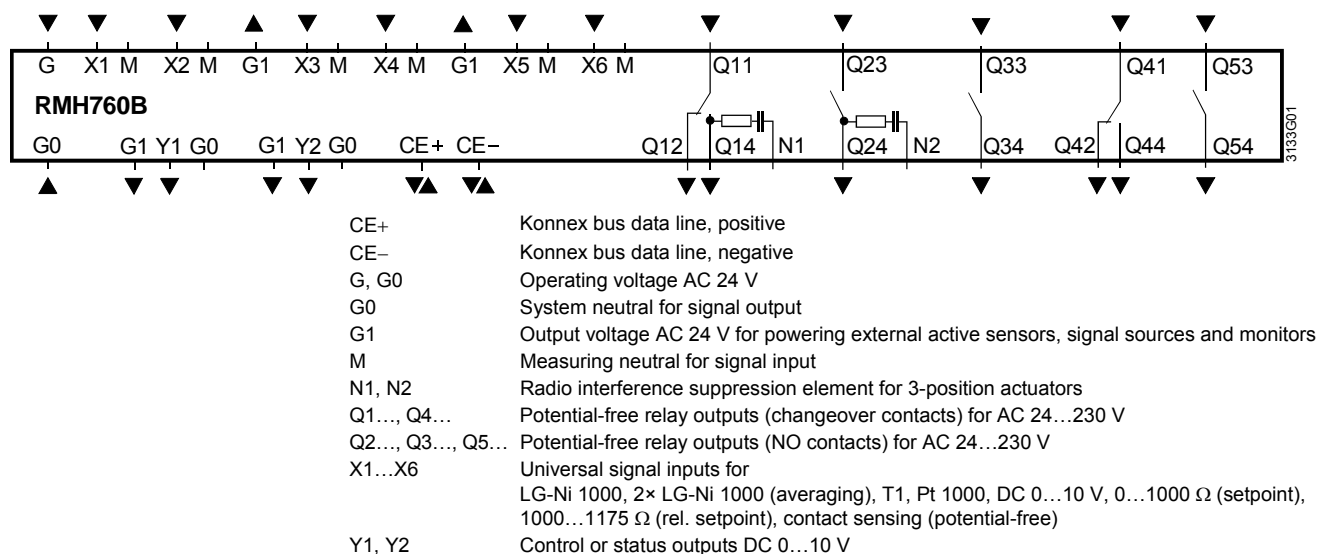

Notes

- Each terminal (spring cage terminals) can accommodate only one solid wire or one stranded wire
- Double terminals are internally interconnected
- With 3-position control of actuators operating on AC 230 V, the radio interference suppression element must be activated. For that purpose, terminal N1 is to be connected to the neutral conductor and a wire link is to be fitted between terminals N1 and N2

Connection examples

Various low-voltage connections

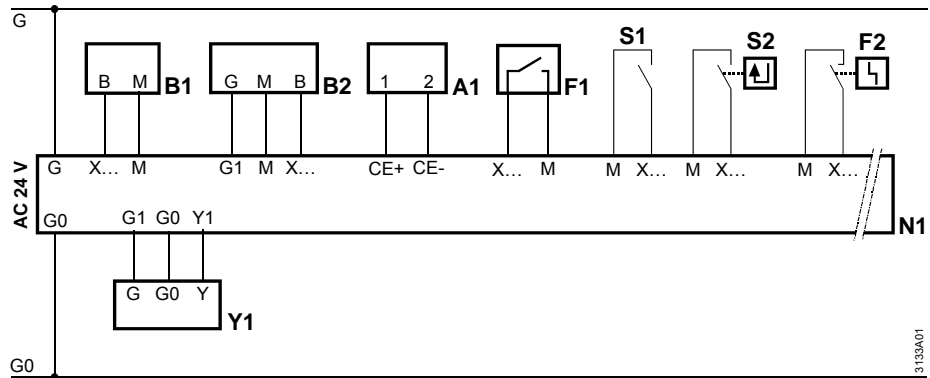

- A1 Konnex device
- B1 Passive sensor (signal source)
- B2 Active sensor (signal source)
- F1 Fault contact (e.g. thermostat)
- F2 Fault contact (e.g. pressure switch) on the burner
- N1 Heating controller RMH760B
- S1 Manual switch, service switch, etc.
- S2 Operational signal (e.g. from burner or shutoff valve)
- Y1 Actuator with DC 0...10 V control input

Connection of 3-position actuators

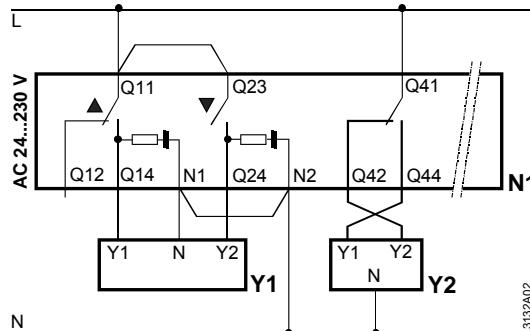

- N1 Heating controller RMH760B
- Y1 3-position actuator for mixing valve
- Y2 3-position actuator for shutoff valve

Connection of 1 twin pump or 2 single pumps

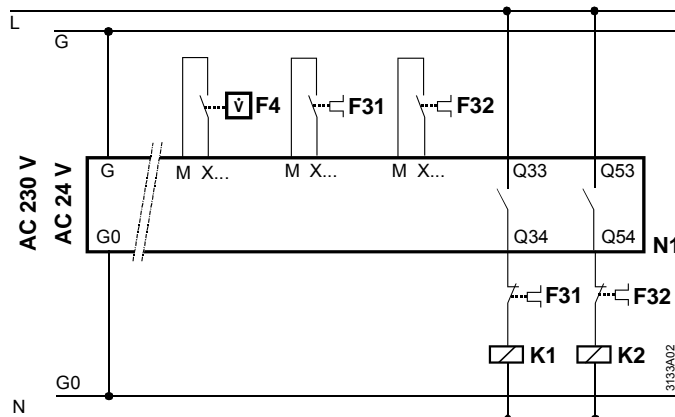

- F3... Overcurrent release contact
- F4 Flow switch
- K1 Motor contactor for pump
- K2 Motor contactor for pump
- N1 Heating controller RMH760B

Connection of safety loop for a 2-stage burner

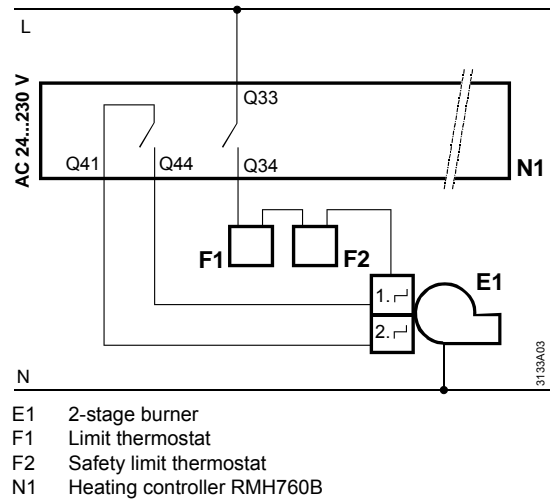

Plant types

Plant type	Description	Plant diagram
H0-1	N1: DHW circuit with storage tank flow controlled via mixing valve and charging pump, connected directly to uncontrolled header (DHW 2 variant)	
H0-2	N1: Weather-compensated heating circuit control with mixing valve and circulating pump, connected directly to uncontrolled header	
H0-3	A3: DHW circuit (DHW 2) N1: Heating circuit	
H0-4	N1: Heating circuit A2: Heating circuit	
H0-5	A3: DHW circuit (DHW 2) N1: Heating circuit A2: Heating circuit	

Plant type	Description	Plant diagram
H0-6	<p>N1: Heating circuit</p> <p>A2(1): Heating circuit</p> <p>A2(1): Heating circuit</p>	
H0-7	<p>A3: DHW circuit (DHW 2)</p> <p>N1: Heating circuit</p> <p>A2(1): Heating circuit</p> <p>A2(2): Heating circuit</p>	
H1-0	<p>N1: Main controller (district heating connection with heat exchanger), control of the secondary flow temperature with 2-port valve in the primary return, heat supply to internal and external consumers</p>	
H1-1	<p>N1: Main controller</p> <p>A3: DHW circuit, storage tank charging from heat exchanger controlled via mixing valve, with primary and secondary pump (DHW 4)</p>	
H1-2	<p>N1: Main controller</p> <p>A2: Weather-compensated heating circuit control with mixing valve and circulating pump, connected to secondary side of header</p>	
H1-3	<p>N1: Main controller</p> <p>A3: DHW circuit (DHW 4)</p> <p>A2: Heating circuit</p>	
H1-4	<p>N1: Main controller</p> <p>A2(1): Heating circuit</p> <p>A2(2): Heating circuit</p>	

Plant type	Description	Plant diagram
H1-5	<p>N1: Main controller</p> <p>A3: DHW circuit (DHW 4)</p> <p>A2(1): Heating circuit</p> <p>A2(2): Heating circuit</p>	
H2-0	<p>N1: Demand-compensated primary controller with mixing valve and circulating pump; heat supply to external consumers</p>	
H2-1	<p>N1: Primary controller</p> <p>A3: DHW circuit with storage tank flow controlled via mixing valve, with charging pump (DHW 2)</p>	
H2-2	<p>N1: Primary controller</p> <p>A2: Weather-compensated heating circuit control with mixing valve and circulating pump</p>	
H2-3	<p>N1: Primary controller</p> <p>A3: DHW circuit (DHW 2)</p> <p>A2: Heating circuit</p>	
H2-4	<p>N1: Primary controller</p> <p>A2(1): Heating circuit</p> <p>A2(2): Heating circuit</p>	
H2-5	<p>N1: Primary controller</p> <p>A3: DHW circuit (DHW 2)</p> <p>A2(1): Heating circuit</p> <p>A2(2): Heating circuit</p>	

Plant type	Description	Plant diagram
H3-0	N1: Boiler temperature control with 1-stage burner and boiler pump	
H3-1	N1: Boiler temperature control A3: DHW circuit with storage tank flow controlled via mixing valve, with charging pump (DHW 2)	
H3-2	N1: Boiler temperature control A2: Weather-compensated heating circuit control with mixing valve and circulating pump	
H3-3	N1: Boiler temperature control A3: DHW circuit (DHW 2) A2: Heating circuit	
H3-4	N1: Boiler temperature control A2(1): Heating circuit A2(2): Heating circuit	
H3-5	N1: Boiler temperature control A3: DHW circuit (DHW 2) A2(1): Heating circuit A2(2): Heating circuit	
H4-0	N1: Boiler temperature control with 1-stage burner and boiler pump, maintained boiler return temperature controlled via mixing valve	

Plant type	Description	Plant diagram
H4-1	<p>N1: Boiler temperature control</p> <p>A3: DHW circuit with storage tank flow controlled via mixing valve, with charging pump (DHW 2)</p>	
H4-2	<p>N1: Boiler temperature control</p> <p>A2: Weather-compensated heating circuit control with mixing valve and circulating pump</p>	
H4-3	<p>N1: Boiler temperature control</p> <p>A3: DHW circuit (DHW 2)</p> <p>A2: Heating circuit</p>	
H4-4	<p>N1: Boiler temperature control</p> <p>A2(1): Heating circuit</p> <p>A2(2): Heating circuit</p>	
H4-5	<p>N1: Boiler temperature control</p> <p>A3: DHW circuit (DHW 2)</p> <p>A2(1): Heating circuit</p> <p>A2(2): Heating circuit</p>	
H5-2	<p>N1: Weather-compensated heating circuit control from heat exchanger connected to uncontrolled header, with 2-port valve in the primary return</p>	
H5-3	<p>A3: DHW circuit with storage tank charging from heat exchanger connected to uncontrolled header (DHW 3)</p> <p>N1: Heating circuit</p>	

Plant type	Description	Plant diagram
H5-4	N1: Heating circuit A2: Heating circuit	
H5-5	A3: DHW circuit (DHW 3) N1: Heating circuit A2: Heating circuit	
H5-6	N1: Heating circuit A2(1): Heating circuit A2(2): Heating circuit	
H5-7	A3: DHW circuit (DHW 3) N1: Heating circuit A2(1): Heating circuits A2(2): Heating circuits	
H6-1	N1: Direct DHW consumption from heat exchanger connected to uncontrolled header, with circulating pump (DHW 6)	
H6-3	N1: DHW circuit (DHW 6) and weather-compensated heating circuit control from heat exchangers, with 2-port valve in the primary return	
H6-5	N1: DHW circuit and heating circuit A2 Heating circuit	

