

LOGIC SP - STP - TP

Variable frequency drive for control and protection of the pump

GB ORIGINAL INSTRUCTIONS FOR USE

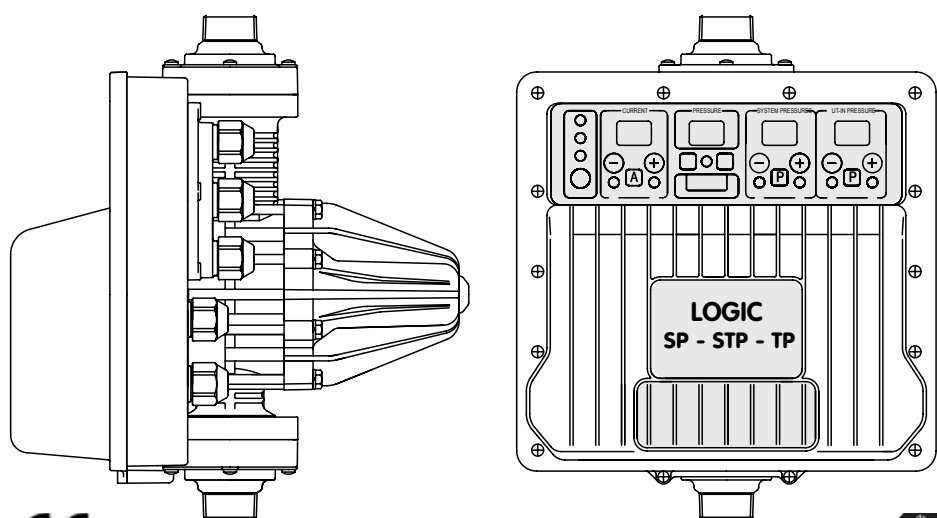

Made in Italy



- The user must carefully read the instructions and observe the regulations contained in this instruction manual.
- The installer and final user must scrupulously observe the relative laws and standards, also in compliance with local regulations.
- The device must only be installed, adjusted and serviced by qualified personnel aware of the risks involved.
- Before installing the device check that its technical characteristics are compatible with those of the pump and the system.**
- Under no circumstances must the device be opened or tampered with, nor must its safety guards ever be removed.
- RISK OF ELECTRIC SHOCK!**
- Disconnect the power supply before accessing the variable frequency drive.**
- The voltage levels inside the inverters are hazardous until all the LEDs have turned off on the panel of the device.**

Replacing the threaded fittings

It is possible to replace the fittings with others with different dimensions (supplied as spare-parts inside the packaging) on the inlet and/or outlet of the device. To replace the fittings, remove the screws, extract the fittings, check that the sealing O-ring is fitted in place, mount the new fittings and tighten the screws again.

Motor cables longer than 40 meters and up to 80 meters max

If the distance between the device and the pump motor is greater than 40 metres, **turn off the power supply to the device**, remove the screws and the cover of the electrical box to access the selector "A", move the cursor to "ON", replace the cover of the electrical box and tighten all the screws again.

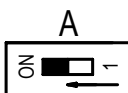

"Soft" start-up - only possible on the SP models

Whenever a series of concomitant causes created by the pump-device-system assembly generates the effect of unstable operation (e.g. oscillations), to eliminate this defect it may be necessary to start up the pump in soft mode compared to the standard start-up. To enable this function, **disconnect the power supply to the device** remove the screws and the cover of the electrical box, to access the selector "B", move the cursor to "ON", replace the cover on the electrical box and retighten all the screws.

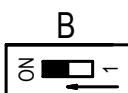

Transferral to another pump

Disconnect the power supply before opening the cover of the electrical box. The device has all the data saved in its memory regarding the pump it was previously mounted on and therefore it will be necessary to reset the parameters following the instructions contained in the section "Control Panel and Adjustments", **paying special attention when setting the absorbed current value of the motor.**

Replacing the pressure sensor

In case of a fault in the pressure sensor, **disconnect the power supply to the device**, discharge the pressure from the system, unscrew the drainage cap and wait for all the water to drain out. Remove the screws and the cover of the electrical box, unscrew the faulty sensor and replace it with the spare one using the relative wrench supplied with the kit. Replace the cover of the electrical box, tighten all the screws again and then screw back the drainage cap, checking that its flange is inside.

Replacing the fuse

In case of having to replace the fuse, disconnect the power supply to the device, remove the screws and the cover of the electrical box, extract the spare fuse, remove the two screws and board protection, extract the faulty fuse and replace it with the spare one. Remount the board guard, tighten the two screws again, replace the cover of the electrical box and tighten all the screws.

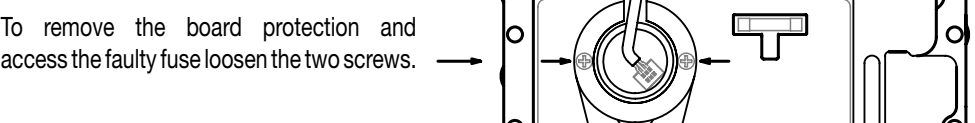

Features and advantages

- Varies the number of revolutions of the electrical pump depending on the water withdrawals from the system in order to maintain constant flow and pressure.**
- Can be installed on surface and submerged pumps.**
- Allows for regulating the system pressure and the pump cut-in.**
- Protects the pump from dry running.**
- Ensures energy savings.**
- Not need for an expansion tank, check valve, filter or fittings.**

Automatic restart and anti-jamming function

In case of stopping due to a water shortage, the device will automatically make 10 double attempts to rearm over the 24 hours following the failure, each lasting approximately 5 seconds to allow the pump and the system to reload if possible. After the last failed rearming attempt, the device will remain permanently in alarm (red Failure LED blinking) pending manual rearming by pressing the "Restart" button. The user can try to rearm the device at any time by pressing the Restart button. If for any reason the pump remains idle for 24 consecutive hours, the device will carry out a start up of the pump motor for about 5 seconds. In case of a temporary blackout, the device will automatically rearm once the electricity returns.

Electromagnetic compatibility and noise filters

The device is manufactured in compliance with the European 2004/108EC standard. **In case of any noise disturbance it is recommended to install a line and/or output filter.**

Models			EMC/RFI line filters	
SP	STP	TP	Description	Item
8.5 - 11 - 13	8.5	---	Epcos 16A 1Ph 250V EMI	B84113H0000B116
---	11	---	Epcos 25A 1Ph 250V EMI	B84113H0000G125
---	---	6 - 9 - 12 - 16	Epcos 16A 3Ph 250V EMI	B84143A0016R105
Models			Output filters	
SP	STP	TP	Description	Item
8.5 - 11	8.5 - 11	6 - 9	Epcos Sine Wave 11A 520Vac	B84143V00011R227
13	---	12 - 16	Epcos Sine Wave 16A 520Vac	B84143V0016R227

The filters are in Protection Class IP 20, any increases to the protection degree (if requested) are the user's responsibility.

Access and wiring of inputs and auxiliary contacts

Disconnect the power supply to the device, remove the screws and the cover located at the rear of the electrical box. Unscrew the ring nuts and remove the caps of the cable glands to be used. Insert the electrical cable into the ring nut and the rubber ring and push it forwards towards the lid. Extract the connectors and connect the cables. Reinsert the connectors, replace the lid, tighten the screws, fit the rubber rungs back into place and tighten the ring nuts.

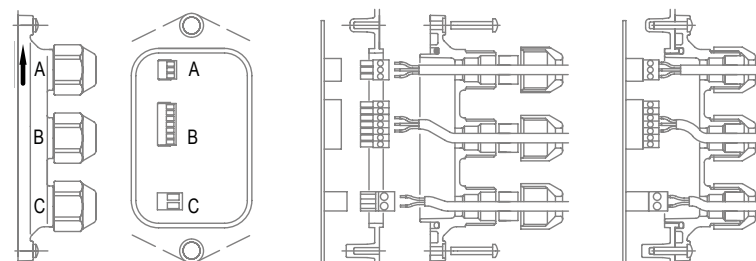

- A Communication between devices** - Only enabled if the devices are set up for communicating.
- B Remote control - ON / OFF switch.** The switch turns off the device, the pump stops and the LED starts blinking red. The switch turns off the device and the LED turns to steady green. B1 B2 B3 B4 switches and level probes. The switch turns off the device if the eater reaches the set level and the LED on the switch turns from steady green to blinking green. The device starts the system again when the water level increases and/or decreases and the LED on the switch turns back to steady green again.
- C Remote alarm - lamp and siren.** The device turns on if the system stops the pump to protect it and the red Failure LED starts blinking. The device turns off once the fault has been removed and the system starts up again.

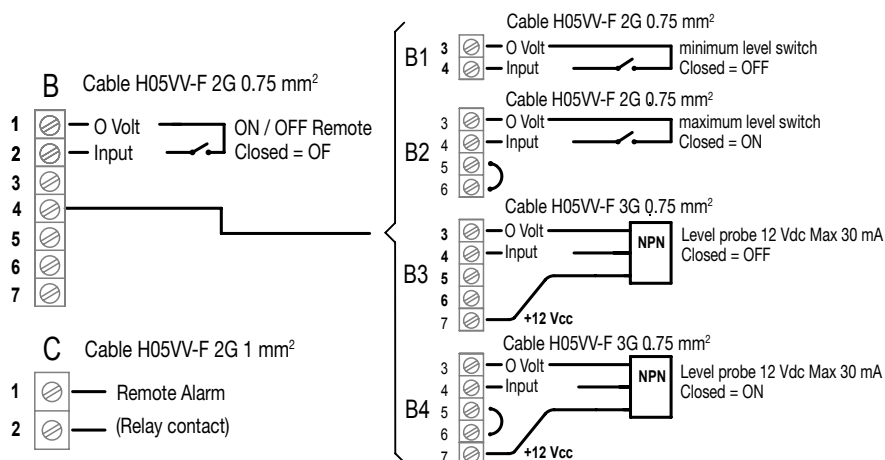

If it is necessary to exploit options B1 or B2 together with the B option, use a 4-pole 0.75 mm² H05 VV-F cable, whereas for option B3 or B4 use a 5-pole 0.75 mm² H05 VV-F cable. In the event of using different cables to those indicated in on the electrical diagram it may be necessary to replace the rubber cable-gland caps of the (supplied as spare parts in the packaging) to ensure IP 65 protection.

Installation and start up

Mount the device in a vertical position directly on the pump or between the pump and the first user. install a ball valve between the device and the system to make it possible to identify whether any anomalies derive from the device or the system. **Make all electrical connections following the diagrams indicated below and connect the power supply.** On the control panel the green "Power on" LED and the red OFF LED on the switch will light up. Blinking dashes will appear on all the displays while the device carries out the set-up operations. When the set-up is completed the factory-set current and pressure values will appear on the display (CURRENT 1.5 A - SYSTEM PRESSURE 3.0 bar - CUT-IN PRESSURE 1.5 bar): The "CURRENT" display will start blinking and the yellow (A) and (P) LEDs will light up. The value of the pressure in the system will appear on the Pressure display. **Set the current value absorbed by the motor as indicated on the relative nameplate.** To adapt the plant to the desired operations, different pressure values can be set than the factory-set ones: system pressure 3 bar - cut-in pressure 1.5 bar. The set pressure value of the system must be lower than the maximum effective pressure generated by the pump and compatible with the desired pump delivery. The set cut-in pressure value must be higher than the pressure extended on the device by the water column height. **After setting the values, press the (ON) button on the switch (green LED lit up) to start.** When the pump is in operation the real value of the current absorbed by the motor will appear on the Current display.

Example of parameters setting

- CURRENT**
Adjustment step 0.5A up to 10 A -1A over 10A. Set the value **immediately over** the value of A indicated on the nameplate. Example: motor current (on nameplate) 6.3 A → max 6,5 A
- SYSTEM PRESSURE**
Adjustment step 0.5 bar. Set the desired value **lower than the maximum effective pressure** generated by the pump. Example: maximum pump pressure 9 bar → max 8,5 bar
- CUT-IN PRESSURE**
Adjustment step 0.1 bar. Set the desired value higher **(0,5 bar) than the pressure** exerted by the water column. Example: water column pressure 1 bar → min 1,5 bar

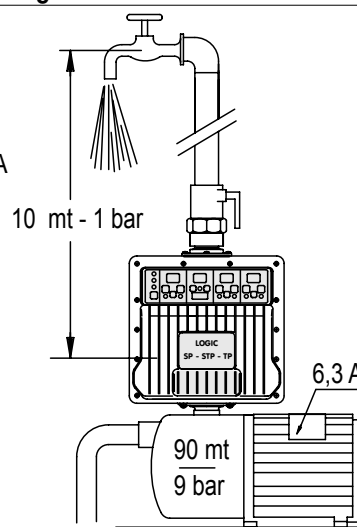

It is possible to change the set pressure values even while the pump is operating. Before changing the value of the absorbed current (amperes) of the motor press the OFF button (red LED lit up) of the switch on the current display.

Electrical wiring

- The electrical wiring must be carried out by a qualified electrician in compliance with local regulations.
- Follow the safety standards. Carry out the earthing connection.** Follow all the instructions on the electrical diagrams.
- The relative devices must exist for protecting against power surges and overloads in compliance with current safety standards.

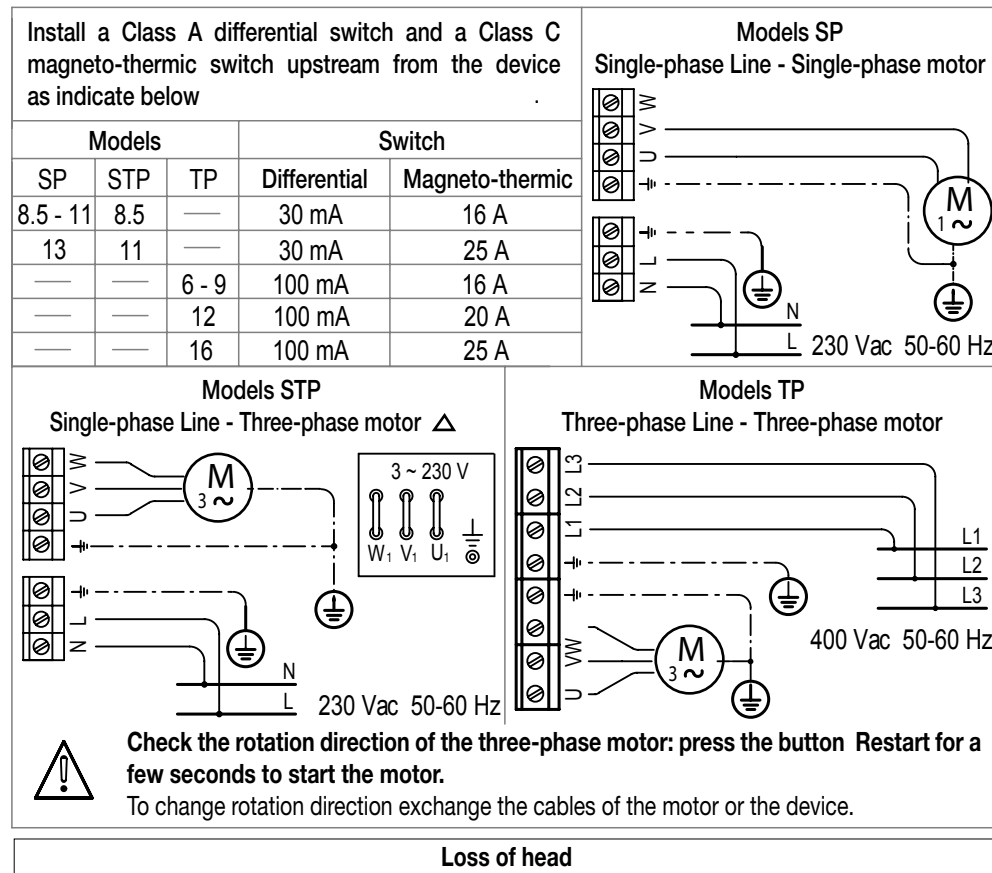

Loss of head

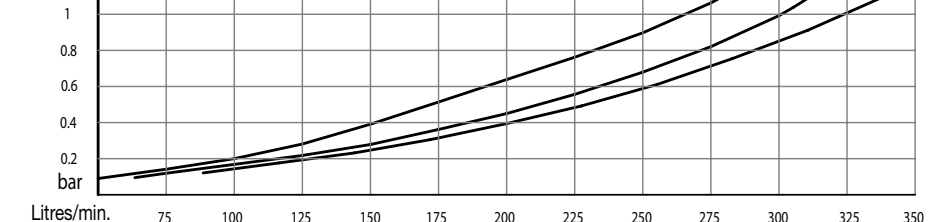

Control and adjustment panel

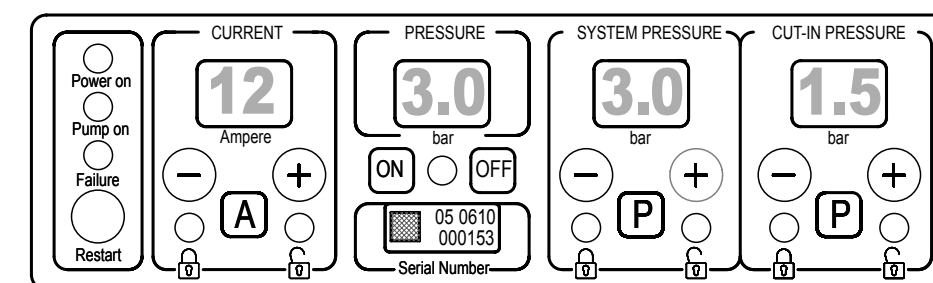

- Power on
- Pump on
- Failure
- Restart
- Green LED lit up
- Yellow LED lit up
- Red LED blinking
- Button
- Button
- Buttons
- Device energised
- Pump running
- Water shortage or malfunctioning
- Reset after failure
- Access and locking of keypad

Setting the value of the current absorbed by the motor

Read the value of the current in Amperes on the pump motor nameplate. Press the (A) button (green LED lit up) and set the value on the display using the (+) (plus) and (-) (minus) buttons (0.5 A steps). Set the value by pressing the (A) button (yellow LED lit up) to lock the adjustment just made. When the pump is running the real motor absorption value will appear on the display.

- Manometer: Indicates the real value of the system pressure.
- Switch: Press the green (ON) button (green LED lit up) to start the pump and the (OFF) button to turn it off (red LED lit up).
- Identification: Specific serial number and data of the device.

Setting the value of the system pressure

Press the (P) button (green LED lit up) and set the value on the display using the (+) (plus) and (-) (minus) buttons (0.5 A steps). After setting the desired value, press the (P) button (yellow LED lit up) to lock the adjustment made.

Setting the cut-in value of the pump

Press the (P) button (green LED lit up) and set the value on the display using the (+) (plus) and (-) (minus) buttons (0.1 bar steps). After setting the desired value, press the (P) button again (yellow LED on) to lock the adjustment made.

Faults and malfunctioning

In case of any faults or malfunctioning, the device will stop the pump and the blinking red "Failure" will light up and the fault code will appear on the "Current" display.

Code	Alarm description and rearming method
E 1	Over-temperature of the device Automatic (1)
E 2	Voltage surge above tolerated level Automatic (2)
E 3	Excessive motor pump absorption Automatic - Manual (3)
E 4	Short-circuit between phases and/or between phase & earth Manual (4)
E 5	Incorrect three-phase motor connection Check the wiring
E 6	Faulty pressure sensor Replace the pressure sensor
E 7	No input phase Check the connect to the mains and the voltage
--	The device fails to turn on Manual (5)
H 1	Input water shortage Manual (6)
H 2	System pressure set higher than the pressure generated by the pump Suction difficulties. Manual (7)

1. The device automatically rearms when the temperature drops below the safety level.
2. The device automatically rearms when the voltage value re-enters within the tolerance value.
3. After one minute the device makes the first of a series of three established restart attempts. If the device fails to restart, press the OFF button (red LED lit up) and check motor operation and that set current is compatible with the nameplate data. Press the ON button (green LED lit up) and then press the Restart button to start up again.
4. **Disconnect the power supply**, wait until all the displays and LEDs have turned off and check the electrical wiring between the device and the motor.
5. No mains voltage. Burnt-out fuse.
6. Check the return of the input water keeping the red Restart button pressed in with a user open until the blinking red Failure led turns off.
7. Check the compatibility of the plant with the settings of the device. Check the correct priming of the pump.

Declaration of CE compliance

The Manufacturer hereby declares under its own exclusive responsibility that the product is compliant with the Essential Safety and Health Protection Requirements laid down by the following directives: EN 60730-1, EN 55014-1, EN 55014-2, EN 61000-3-2 and EN 61000-3-3.

MODELS SP - STP - TP COM - Pressure sets (two pumps)

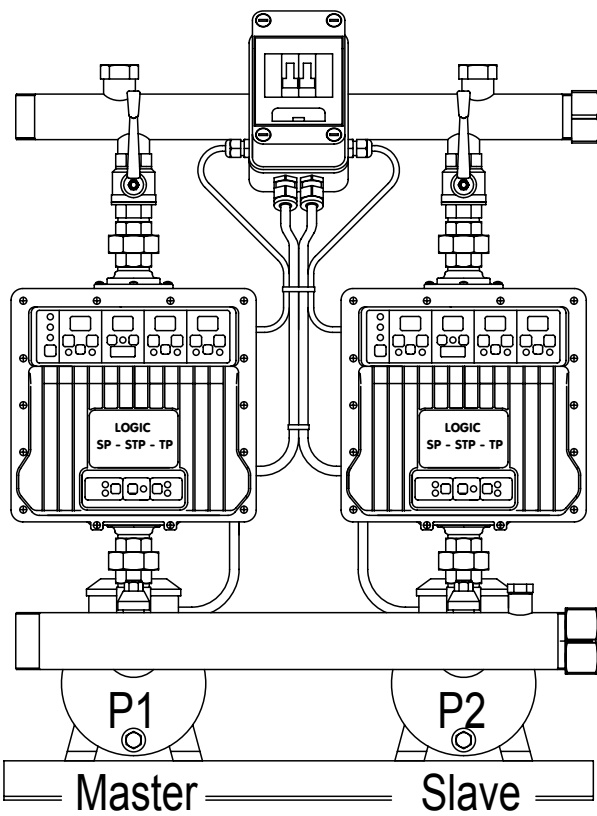

- The user must carefully read the instructions and observe the regulations contained in this instruction manual.
- The installer and final user must scrupulously observe the laws and standards, also in compliance with local regulations.
- Pressure set unit must only be installed, adjusted and serviced by qualified personnel aware of the risks involved.
- Before installing the pressure set unit check that its technical characteristics are compatible with those of the devices, the pumps and the system.
- Under no circumstances must the multipump unit be opened or tampered with, nor must its safety guards ever be removed.
- RISK OF ELECTRIC SHOCK!**
 Disconnect the power supply before accessing the variable frequency drive.
The voltage levels inside the inverters are hazardous until all the LEDs have turned off on the panel of each device.

MODELS SP - STP - TP COM - Pressure sets (three or more pumps)

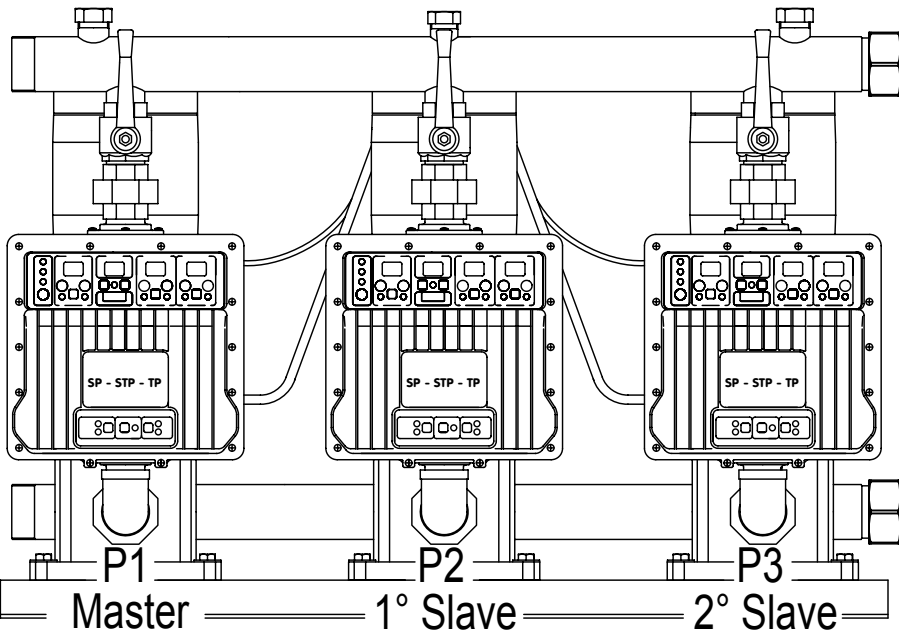

Starting up the third device

- Only start up the first two devices of the pressure set unit, carefully following the instructions for the unit with two pumps, and after checking the operation carry out the following instructions to activate the third device, and subsequently also the fourth, the fifth and so on, up to as many as ten devices.
- Turn on the power supply to the first two devices in the pressure set unit, press the **[OFF]** button of the Master device and energise the third device of the unit which is actually the second Slave.
- The green POWER ON LED and the red **[OFF]** LED will light up on the **Control and adjustment panel** of the device and blinking dashes will appear on all the displays while the device carries out the set-up. The green Master LED and the yellow **[K]** LED will light up on the **communication panel**.
- At the end of the set-up the yellow **[A]** and **[P]** LEDs will also light up.
- Intermittent ampere values will appear on the Current display and all the other displays will show the system pressure and cut-in pressure values set in the factory.
- The manometer will indicate the real instantaneous pressure in the system.
- Press the **[A]** button on the control and adjustment panel to unset the adjustment, **set the ampere value indicated on the motor nameplate** and then press the **[A]** button to confirm (yellow LED lit up), the **[ON]** button (green LED lit up) to start up the pump, and finally, the **[OFF]** button (red LED lit up).
- Programme the device by following the procedure indicated in point B - 1, 2, 3, 4, 5, and 6.
- If the communication functions correctly, the green LED [I] will light up on all the devices.**
Press the [ON] button (green LED lit up) on the Control and Adjustment panel of all the devices to start up the system.

Installation

Correctly assemble the devices and the pumps of the pressure unit after carefully reading the instructions above relating to the single devices and then connect the unit system to the water and electricity mains, and turn the power supply on.

Control and adjustment panel

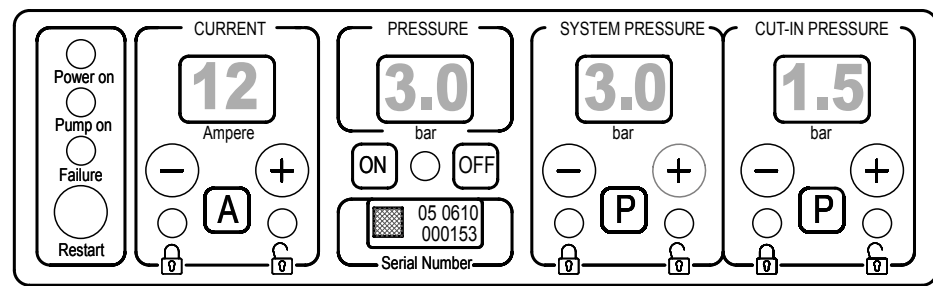

Communication panel

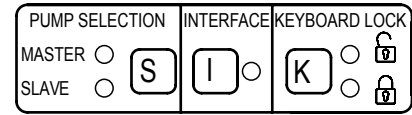

The green Power ON LED and the red **[OFF]** LED will light up on the **Control and adjustment panel** of both the device and blinking dashes will appear on all the displays while the device carries out the set-up. The green Master LED and the yellow **[K]** LED will light up on the **communication panel**.
At the end of the set-up the yellow **[A]** and **[P]** LEDs will also light up.
Intermittent ampere values will appear on the Current display and all the other displays will show the system pressure and cut-in pressure values set in the factory.

Programming

The following procedure must be strictly followed to set the operating sequence and methods on the Master and each Slave device.

- A - Set the following on the control and adjustment panel of both devices

1 -----Master Device -----
Press the **[A]** button to unset the adjustment, set the ampere value indicated on the nameplate of the motor, press the **[A]** button to confirm (yellow LED lit up), the **[ON]** button (green LED lit up) to start up the pump, and finally, the **[OFF]** button (red LED lit up).

2 -----Slave Device -----
For the Slave device, repeat the steps indicated above for the Master Device.

- B - Set the following on the communication panel of both the devices (led ☀ On, led ○ Off)

1 -----Master Device -----
Press the **[K]** button (yellow LED turned off, green LED lit up) to unset the adjustment.

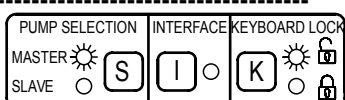

2 -----Slave Device -----
Press the **[K]** button (yellow LED turned off, green LED lit up) to unset the adjustment and the **[S]** button to select the Slave Device (yellow LED lit up).

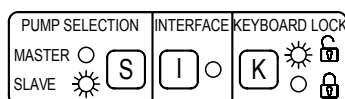

3 -----Slave Device -----
Press the **[I]** button to transfer the data from the Master to the Slave (green LED lit up)

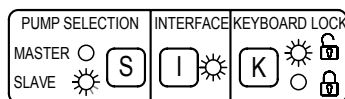

4 -----Slave Device -----
Press the **[I]** button once again to confirm (green LED turned off).

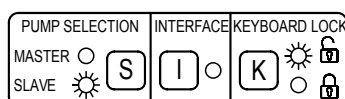

5 -----Master Device -----
Wait a few seconds and press the **[K]** button (yellow LED lit up) to lock the adjustment.

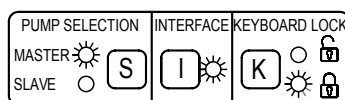

6 -----Slave Device -----
Press the **[K]** button (yellow LED lit up) to lock the adjustment.

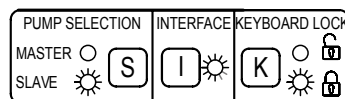

If the communication functions correctly, the green LED [I] will light up on all the devices.
Press the [ON] button (green LED lit up) on the Control and Adjustment panel of all the devices to start up the system.

When the pump is running the value of the absorbed power of the motor will be displayed on the Current display and the value of the pressure in the system will appear on the pressure display.

To change the set system pressure and cut-in values (bar) of both devices, act on the Master device only, even while the pumps are running.

To change the absorbed current value set for the motor (Ampere) press the **[OFF]** button (red LED lit up) and then display Current of the relative device.

Connect the remote control and the alarms and level switches to the Master Device, and for greater safety, also connect them in parallel on the Slave devices to prevent any problems in case of malfunctioning of the Master Device.

General reset of the device

If there are any setting errors or if it is necessary to transfer the device onto another pump, the system must be reset in compliance with the following procedure:
Press the red **[OFF]** button on the control and adjustment panel (the green LED turns red).
Press the **[K]** button four times in rapid sequence (LEDs: yellow, green, yellow, green, yellow)

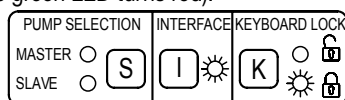

If the operation is correct, after a few seconds the device will automatically turn on.
Start up the devices again and check the operation of the pumps, devices and system.

Operation

The Master device controls the Slave devices and manages the operation of the unit.
Initially, the pump on which the Master device is mounted will start up first, but if the demand for water is such that this pump is unable to maintain the set system pressure values, then the second pump on which the Slave device is mounted will automatically start up.

Every time the pumps stop, it will be the second, third and/or fourth pump etc. to start up first, depending on how many pumps are installed, until finally returning to the Master device and so on.

Master - By pressing the **[OFF]** button (red LED lit up) the Master Device is disabled and the unit stops.

Slave - By pressing the **[OFF]** button (red LED lit up) only the relative Slave Device is disabled.

Alternating the pumps during continuous operation

If for any reason one or more pumps are working continuously, in order to guarantee uniform wear and tear of the pumps, every sixty minutes of continuous operation of a pump, a forced exchange will be made with another pump on stand-by.
The changeover respects the alternating sequence of all the devices.

Automatic restart and anti-jamming function

In case of stopping due to a water shortage, the devices will automatically make 10 double attempts to rearm over the 24 hours following the failure, each lasting approximately 5 seconds to allow the pumps and the system to reload if possible.

After the last failed rearming attempt, the devices will remain permanently in alarm (red Failure LED blinking) pending manual rearming by pressing the "Restart" button .

The user can try to rearm the devices at any time by pressing the Restart button .

If for any reason the pumps remain idle for 24 consecutive hours, the devices will carry out a start up of the pump motor for about 5 seconds without affecting.
In case of a temporary blackout, the pressure set will automatically rearm once the electricity returns.

Variable master

In case of malfunctioning of the Master Device due to one of the following faults: E3 (permanent intervention with the fourth stop), E4, E5, or E6, the system will transfer the operation to the Slave device immediately upstream from the Master.

Once the original Master Device has been reset, it will automatically be reintegrated into the system as a Slave device.

Communication faults between devices

In case of communication breakdowns, the code C1 will appear on the "CURRENT" display of the panel.
Main causes: communication cable malfunctioning, disconnected or not correctly wired.
One or more devices malfunctioning, disconnected or manually excluded from the unit.

The malfunctioning devices can be recognised by the blinking red "Failure" LED.
The devices not able to communicate can be recognised by the [I] LED which will be turned off.

Master not working: the first Slaves will replace the Master and manage the remaining Slave devices.
Master working but not able to communicate: The Master and the Slaves will operate independently.
Slave not working: the unit excludes the faulty Slave and operates normally.
Slave working but not able to communicate: the device will operate independently.

If the Master and Slave devices which are not operating and/or not able to communicate, start to work and/or communicate again, they will automatically be reintegrated into the group.

Connecting the communication cable between two devices

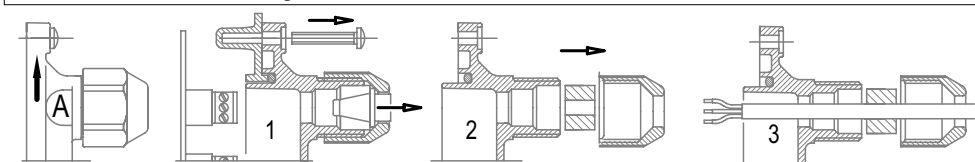

- 1 - Remove the screws and take off the cover located at the rear of the electrical box.
- 2 - Unscrew the ring nut and remove the cap of the cable gland A.
- 3 - Insert the cable into the ring nut and the cable gland and thread it through the cover.

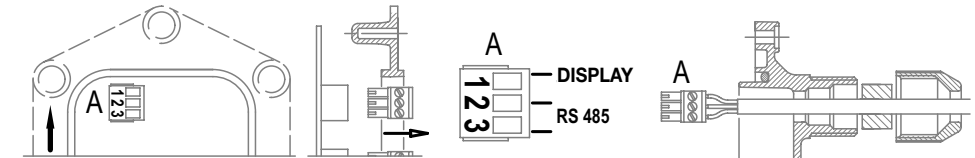

- 4 - Extract the connector and connect the cable supplied with the device.

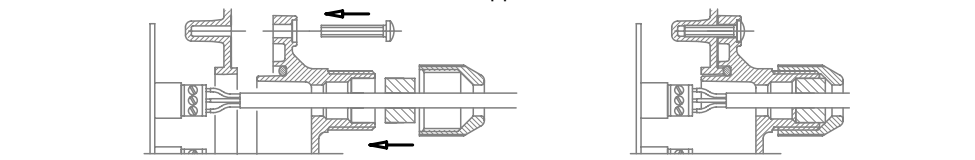

- 5 - Insert the connector into the female connector, remount the cover, tighten the screws, fit the cable gland back into place and firmly tighten the ring nut.

Connecting the communication cable between more than two devices

For the SP STP models use the same connector and cable gland B to connect the second Slave Device and so on.

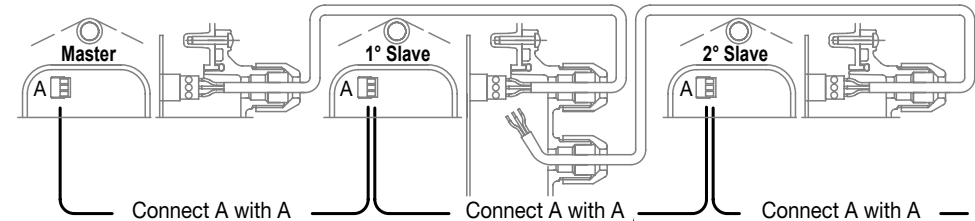

For the TP models use the second connector B and cable gland B to connect the second Slave Device and so on.

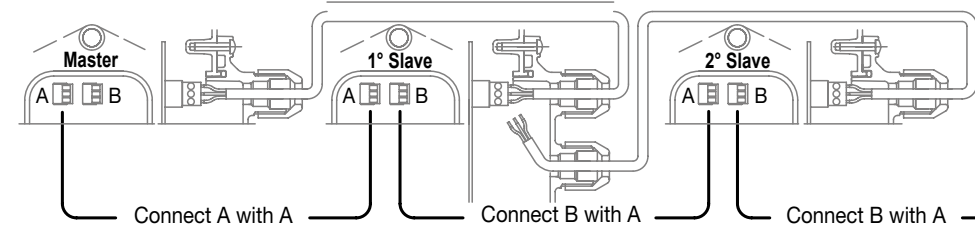

MODELS AND TECHNICAL FEATURES

	SP - SINGLE-PHASE/SINGLE-PHASE			STP SINGLE-PHASE/THREE-PHASE		TP -THREE-PHASE/ THREE-PHASE			
	SP 8.5	SP 11	SP 13	STP 8.5	STP 11	TP 6	TP 9	TP 12	TP 16
VOLTAGE/MOTOR									
MODELS									
Mains voltage	1 ~ 230 Vac	1 ~ 230 Vac	1 ~ 230 Vac	1 ~ 230 Vac	1 ~ 230 Vac	3 ~ 400 Vac	3 ~ 400 Vac	3 ~ 400 Vac	3 ~ 400 Vac
Acceptable voltage fluctuations	+/- 15%	+/- 15%	+/- 15%	+/- 15%	+/- 15%	+/- 15%	+/- 15%	+/- 15%	+/- 15%
Frequency (automatic recognition)	50 / 60 Hz	50 / 60 Hz	50 / 60 Hz	50 / 60 Hz	50 / 60 Hz	50 / 60 Hz	50 / 60 Hz	50 / 60 Hz	50 / 60 Hz
Frequency 140 Hz motor	—	—	—	—	—	—	—	—	—
Pump motor voltage	1 ~ 230 Vac	1 ~ 230 Vac	1 ~ 230 Vac	3 ~ 230 Vac	3 ~ 400 Vac	3 ~ 400 Vac	3 ~ 400 Vac	3 ~ 400 Vac	3 ~ 400 Vac
Maximum pump motor current	8,5 A	11 A	13 A	8,5 A	11 A	6 A	9 A	12 A	16 A
Maximum pump motor power	1,3 kW - 1,7 HP	1,5 kW - 2 HP	2,2 kW - 3 HP	1,9 kW - 2,5 HP	2,2 kW - 3 HP	2,2 kW - 3 HP	3 kW - 4 HP	5,5 kW - 7,5 HP	7,5 kW - 10 HP
Soft "engine start"	Yes	Yes	Yes	Yes	—	—	—	—	—
Electrical connection cable to mains H07 RN-F	3G 1,5 mm² L 1,5 m schuko plug								
Electrical connection cable to motor H07 RN-F	3G 1,5 mm² L 1,5 m								
Length of cable up to 80 m	Yes	Yes	Yes	Yes	Yes	Yes	Yes	Yes	Yes
Maximum operating	16 bar	16 bar	16 bar	16 bar	16 bar	16 bar	16 bar	16 bar	16 bar
Adjustable system pressure	2 ÷ 12 bar	2 ÷ 12 bar	2 ÷ 12 bar	2 ÷ 12 bar	2 ÷ 12 bar	2 ÷ 12 bar	2 ÷ 12 bar	2 ÷ 12 bar	2 ÷ 12 bar
Adjustable cut-in pressure	1 ÷ 11 bar	1 ÷ 11 bar	1 ÷ 11 bar	1 ÷ 11 bar	1 ÷ 11 bar	1 ÷ 11 bar	1 ÷ 11 bar	1 ÷ 11 bar	1 ÷ 11 bar
Minimum flow	~ 1 l/min	~ 1 l/min	~ 1 l/min	~ 1 l/min	~ 1 l/min	~ 1 l/min	~ 1 l/min	~ 1 l/min	~ 1 l/min
Maximum operating temperature	60° C	60° C	60° C	60° C	60° C	60° C	60° C	60° C	60° C
Protection degree	IP 65	IP 65	IP 65	IP 65	IP 65	IP 65	IP 65	IP 65	IP 65
Digital manometer	Yes	Yes	Yes	Yes	Yes	Yes	Yes	Yes	Yes
Digital ammeter	Yes	Yes	Yes	Yes	Yes	Yes	Yes	Yes	Yes
Dry running protection	Yes	Yes	Yes	Yes	Yes	Yes	Yes	Yes	Yes
Timed automatic rearming	Yes	Yes	Yes	Yes	Yes	Yes	Yes	Yes	Yes
Anti-jamming function	Yes	Yes	Yes	Yes	Yes	Yes	Yes	Yes	Yes
Protection fuse	Yes	Yes	Yes	Yes	Yes	Yes	Yes	Yes	Yes
Short-circuit protection between phases	Yes	Yes	Yes	Yes	Yes	Yes	Yes	Yes	Yes
Short-circuit protection between phases and earth	Yes	Yes	Yes	Yes	Yes	Yes	Yes	Yes	Yes
Over-current protection	Yes	Yes	Yes	Yes	Yes	Yes	Yes	Yes	Yes
Voltage surge protection	Yes	Yes	Yes	Yes	Yes	Yes	Yes	Yes	Yes
Over-temperature protection	Yes	Yes	Yes	Yes	Yes	Yes	Yes	Yes	Yes
Pressure sensor fault detection	Yes	Yes	Yes	Yes	Yes	Yes	Yes	Yes	Yes
Removable pressure sensor	Spare part available on request								
Prearrangement remote ON/OFF connection	Yes	Yes	Yes	Yes	Yes	Yes	Yes	Yes	Yes
Prearrangement float switch and level probe connections	Yes	Yes	Yes	Yes	Yes	Yes	Yes	Yes	Yes
Prearrangement remote alarm connection	Yes	Yes	Yes	Yes	Yes	Yes	Yes	Yes	Yes
Accumulation	Incorporated	Incorporated	Incorporated	Incorporated	Incorporated	Incorporated	Incorporated	Incorporated	Incorporated
Check valve	Incorporated	Incorporated	Incorporated	Incorporated	Incorporated	Incorporated	Incorporated	Incorporated	Incorporated
Water discharge	Yes	Yes	Yes	Yes	Yes	Yes	Yes	Yes	Yes
Male connections	1" - 1"	1" 1/4 - 1" 1/4	1" 1/4 - 1" 1/4	1" - 1"	1" 1/4 - 1" 1/4	1" 1/4 - 1" 1/4	1" 1/4 - 1" 1/4	1" 1/4 - 1" 1/4	1" 1/4 - 1" 1/4
Interchangeable male connectors	1" 1/4 - 1" 1/4	1" 1/2 - 1" 1/2	1" 1/2 - 1" 1/2	1" 1/4 - 1" 1/4	1" 1/2 - 1" 1/2	1" 1/2 - 1" 1/2	1" 1/2 - 1" 1/2	1" 1/2 - 1" 1/2	1" 1/2 - 1" 1/2
Stainless steel screws	Yes	Yes	Yes	Yes	Yes	Yes	Yes	Yes	Yes
Overall dimensions and weight	260 x 312 x 285 mm / ~ 5 Kg								

Communication between devices ----- **For each model is available the "COM" version that is standardly equipped with interface and communication cable**

Attention - Carefully check the technical features of the model to be used, and make sure that they are compatible with those of the pump and the system.